

Customer/Wholesaler:	Date:	Job Name:	Model Specified:	Quantity:
Contractor:		Architect/Engineer:		

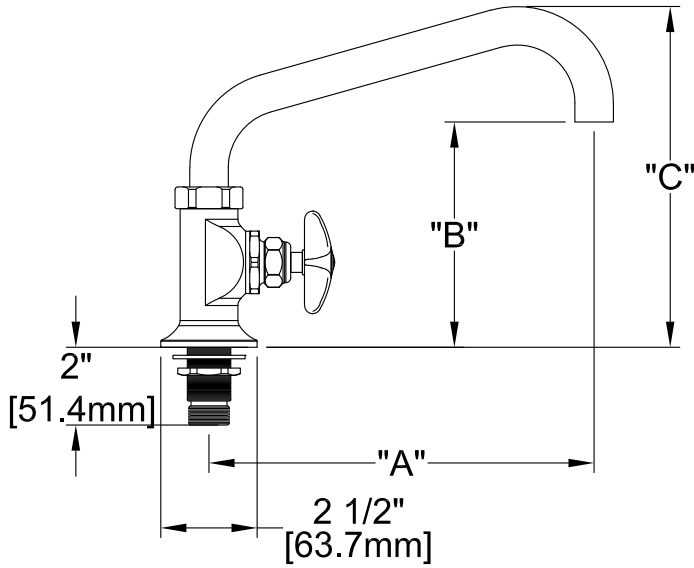

MODEL:

5012 3/4 FAUCET SDXH 10SS

5014 3/4 FAUCET SDXH 14SS

OPTIONS OR MODIFICATIONS:

OTHER _____

- FEATURES
- CONTROL VALVE
- * SINGLE DECK
 - * STEM - LEFT HAND
 - * HOT AND COLD INDEX BUTTONS
 - * SWIVELLING SEAT DISK
 - * STAINLESS STEEL SEAT
 - * STAINLESS STEEL SEAT SCREW
 - * STAINLESS STEEL HANDLE SCREW

- SYSTEM LIMITS
- * TEMP: 40°F MIN. TO 160°F MAX.
 - * PRESSURE: 200 PSI MAX. STATIC
 - * 29 GPM AT 80 PSI (109.1 L/min @550 KPa)

- SHIPPING WEIGHT
- * 7.0 LBS

- PRODUCT COMPLIANCE:
- * ASME A112.18.1 / CSA B125.1
 - * NSF 61 - Section 9
 - * NSF 372 (Low Lead Content)

MODEL	DIM "A"	DIM "B"	DIM "C"
5012	10" [254.0mm]	5-7/8" [148.9mm]	10" [225.3mm]
5014	14" [355.6mm]	7" [177.6mm]	14" [253.8mm]

ROUGH-IN:

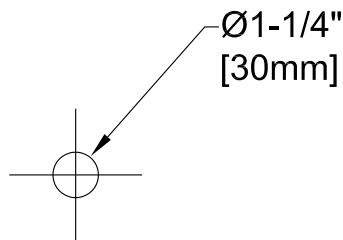

Replacement Parts for Deck Mount Faucets

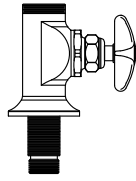

5000
CONTROL VALVE



2000-7500
SCREW



2000-8000
RED BUTTON
AND
2000-8001
BLUE BUTTON

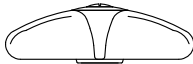

CROSS HANDLE



2000-3002
BIBB CAP



73657
DUCK GASKET



2000-5000
WASHER

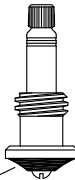

5000-0007
RH SWIVEL
STEM

73550
SEAT WASHER

1000-7502
SCREW



73521
LUBE

5000-0002
14" SWING SPOUT

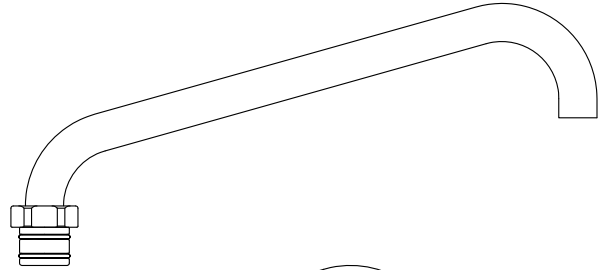

5000-0001
10" SWING SPOUT

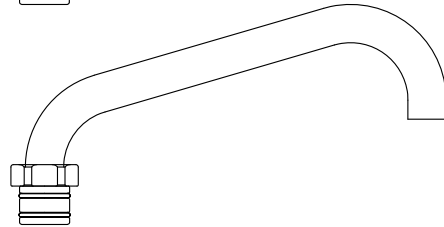

3983
CROSS HANDLE KIT

73849
WASHER



6651-9000
3/4" LOCK NUT

5000-0010
RH SWIVEL
STEM REPAIR
KIT