

Customer/Wholesaler:	Date:	Job Name:	Model Specified:	Quantity:
Contractor:		Architect/Engineer:		

**MODEL:**

- 5312 3/4 FAUCET 8DLH 10SS
- 5314 3/4 FAUCET 8DLH 14SS

**OPTIONS OR MODIFICATIONS:**

- OTHER \_\_\_\_\_

**FEATURES:**

- \* 8" DECK MOUNT FAUCET
- \* SWIVELING SEAT DISKS
- \* HOT SIDE STEM - RIGHT HAND
- \* COLD SIDE STEM - LEFT HAND
- \* STAINLESS STEEL SEATS
- \* STAINLESS STEEL SEAT SCREWS
- \* STAINLESS STEEL HANDLE SCREWS

**SYSTEM LIMITS**

- \* TEMP: 40°F MIN. TO 160°F MAX.
- \* PRESSURE: 200 PSI MAX. STATIC
- \* 37 GPM AT 80 PSI (140.0 L/min @550 KPa)

**SHIPPING WEIGHT**

- \* 8.25 LBS

**PRODUCT COMPLIANCE:**

- \* ASME A112.18.1 / CSA B125.1
- \* NSF 61 - Section 9
- \* NSF 372 (Low Lead Content)

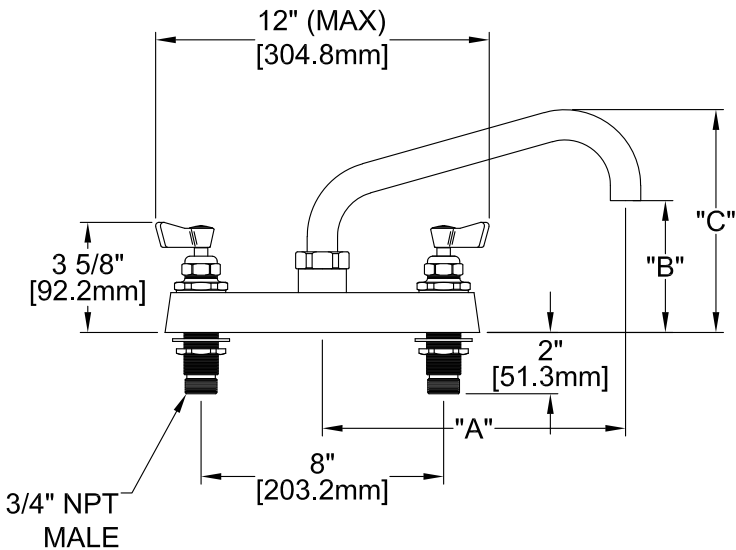

**FOOTPRINT:**

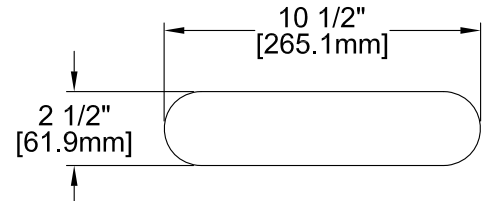

MODEL	DIM "A"	DIM "B"	DIM "C"
5312	10" [254.0mm]	4-1/4" [108.0mm]	7-3/8" [187.3mm]
5314	14" [355.6mm]	5-1/2" [140.0mm]	8-1/2" [215.2mm]

**ROUGH-IN:**

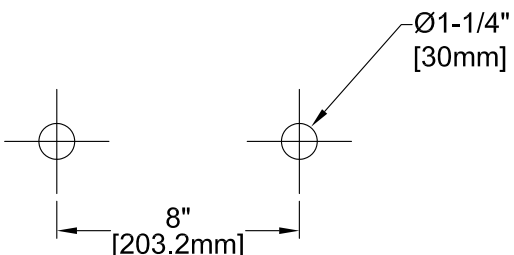

## Replacement Parts for Deck Mount Faucets

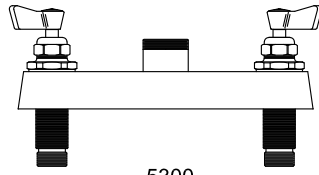

5300  
CONTROL VALVE



2000-7500  
SCREW



2000-8000  
RED BUTTON  
AND  
2000-8001  
BLUE BUTTON



LEVER HANDLE



2000-3002  
BIBB CAP



73657  
DUCK GASKET



2000-5000  
WASHER

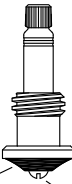

5000-0006  
LH SWIVEL  
STEM  
OR  
5000-0007  
RH SWIVEL  
STEM

73550  
SEAT WASHER

1000-7502  
SCREW



73521  
LUBE

5000-0002  
14" SWING SPOUT

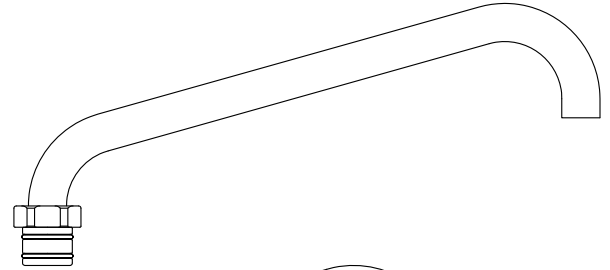

5000-0001  
10" SWING SPOUT

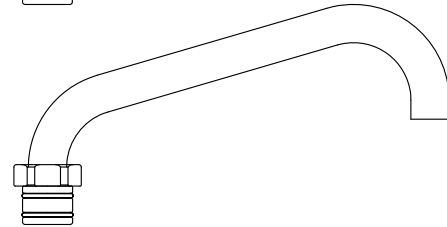

2000-0002  
HANDLE LEVER KIT

5000-0010  
RH SWIVEL  
STEM REPAIR  
KIT  
OR  
5000-0011  
LH SWIVEL STEM

73849  
WASHER



6651-9000  
3/4" LOCK NUT

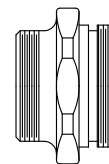

73570  
RIGHT HAND  
STEM ADAPTER  
OR  
73569  
LEFT HAND  
STEM ADAPTER