

FISHER[®]

MANUFACTURING COMPANY
Commercial Faucets Since 1936

CATALOG NO. 26



SCAN TO SIGN UP
FOR UPDATES



WWW.FISHERFAUCETS.COM | 800-421-6162

TABLE OF CONTENTS

FAMILY	CONTENT	PAGE	FAMILY	CONTENT	PAGE
Table of Content	Table of Content	1	¾" Pot Filler Faucets- Brass	¾" Pot Filler Faucets- Brass	1-2
Warranty	Warranty	2		¾" Control Valves - Brass	3
We Believe In	We Believe In	3		¾" Accessories	4
About Fisher	About Fisher	4	¾" Pot Kettle Filler Faucets- Brass	¾" Pot Kettle Filler Faucets- Brass	1-2
Fisher 5 Solutions	Fisher 5 Solutions	5		¾" Control Valves - Brass	3
½" Kitchen Faucets- Ceramic	½" Sink Faucets- Ceramic	1-3		¾" Accessories	4
	½" Bar & Hand Sink Faucets - Ceramic	4-5	Dish Machine & Scrap Fittings - Brass	Dish Machine & Scrap Fittings - Brass	1-2
	½" Pot Filler Faucets- Ceramic	6	Dipperwell Faucets- Brass	Dipperwell Faucets- Brass	1-2
	Wallmount vs Backsplash	7	Foot and Knee Valves - Brass	Foot and Knee Valves - Brass	1-3
	½" Service Sink Faucets- Ceramic	8-9		½" Control Valve Faucets	4
	½" Control Valves - Ceramic	10-11	Glass Fillers - Brass	Glass Fillers - Brass	1-2
	½" Faucet Components & Accessories	12-14	½" Kitchen Faucets- Stainless Steel	½" Sink Faucets- Stainless Steel	1-3
½" Pre-Rinse Units- Ceramic	½" Pre-Rinse Units- Ceramic	1-3		½" Bar & Hand Sink Faucets - Stainless Steel	4-5
	½" Pre-Rinse Control Valves- Ceramic	4-5	½" Pre-Rinse Units - Stainless Steel	½" Pot Filler Faucets - Stainless Steel	6
	Pre-Rinse Sub Assemblies	6		½" Control Valves- Stainless Steel	7-8
	Pre-Rinse Accessories	7-8		½" Faucet Components & Accessories- Stainless Steel	9-10
½" Pot Filler Hose, Utility Spray & Glass Filler Units - Ceramic	½" Pot Filler Hose, Utility Spray & Glass Filler Units - Ceramic	1		½" Pre-Rinse Units - Stainless Steel	1-3
	½" Pot Filler Hose - Ceramic	2		½" Pre-Rinse Control Valves - Stainless Steel	4-5
	½" Utility Spray Unit & Glass Filler Hose - Ceramic	3		Pre-Rinse Sub Accessories - Stainless Steel	6
	Hose Unit Accessories	4-5		Pre-Rinse Accessories - Stainless Steel	7
	½" Pot/Utility & Glass Filler Control Valves - Ceramic	6-7	Foot and Knee Valves - Stainless Steel	Foot and Knee Valves - Stainless Steel	1-3
	½" Pot Filler, Glass Filler & Utility Spray Sub Assemblies	8		½" Control Valve Faucets	4
	½" Glass Filler & Utility Spray Sub Assemblies	9	Glass Filers - Stainless Steel	Glass Filers - Stainless Steel	1-2
	Accessories	10	Reel Rinse Units	Reel Rinse Units	1-3
Glass Filler- Ceramic	Glass Filler- Ceramic	1-2		Reel Rinse Units Installation Kits	4-5
½" Lavatory and Hand Sink Faucets- Brass	½" Lavatory and Hand Sink Faucets- Brass	1-2		Reel Rinse Mounting	6,8-9
	½" Control Valves & Accessories - Brass	3	Drinking	Drinking	1-2
Navigator Electronic Faucets - Brass	Sensor Faucets - Brass	1-2		Drain Accessories	3-4
¾" Faucets- Brass	¾" Faucets- Brass	1-2	Gas Hoses	Gas Hoses	1-2
	¾" Control Valves - Brass	3		Kitchen Faucets	1-4
	¾" Components & Accessories	4		½" & ¾" Kitchen Faucet Accessories	5-6
				Components	7-8
			Price List	Price List	1-13

WARRANTY

LIMITED WARRANTY

READ THIS LIMITED WARRANTY BEFORE INSTALLING OR USING THIS PRODUCT. IF THESE TERMS ARE NOT ACCEPTABLE TO YOU, IMMEDIATELY RETURN THIS PRODUCT TO FISHER MANUFACTURING COMPANY OR THE DEALER WHICH YOU BOUGHT THIS ITEM(S) FROM BEFORE INSTALLING AND/OR USING THESE PRODUCTS.

Fisher Manufacturing Company makes the following limited warranties. These limited warranties extend to the original Fisher Manufacturing Company purchaser only and are not eligible to be transferred.

Fisher Manufacturing Company warrants its products and parts thereof (except as noted below) against defects in materials or workmanship for a period shown below on the chart after the date of the original purchase. During this period Fisher Manufacturing Company will replace a defective product or part without charge to you, provided that the entire product is delivered to Fisher Manufacturing Company. All transportation and insurance charges for shipping the product to and from Fisher Manufacturing Company must be provided by you. Charges for transportation and insurance may, at the option of Fisher Manufacturing Company, be refunded depending upon our investigation of the warranty claim. This warranty does not cover the external finish (except at the date of the original purchase) or labor costs not specifically authorized by Fisher Manufacturing Company.

EFFECTIVE JANUARY 1, 2021

PRODUCT DESCRIPTION	WARRANTY PERIOD
Chrome Coated Brass	4 Years
Chrome Coated Brass Ceramic	4 Years (Ceramic Disk Stems Lifetime Warranty)
Stainless Steel	10 Years
Gas Hoses	10 Years
DrainKing Waste Valves	99 Year Warranty (Lever Handle - 1 Year)
Motion Sensor Faucets	3 Years
Hose Reels Powder Coated Steel	2 Years
Hose Reels Stainless Steel	2 Years

PURCHASERS RESPONSIBILITY

The above warranties are subject to the following conditions:

1. You must retain your original bill of sale or other proof of purchase.
2. You must notify Fisher Manufacturing Company within thirty (30) days after you discover a defective product or part.
3. These warranties are effective only if the product is purchased and operated in the U.S.A.
4. All warranty servicing of this product must be made by Fisher Manufacturing Company.
5. The warranties do not extend to any product or parts which have been subjected to misuse, neglect, accident, improper installation, improper maintenance or use in violation of the instructions furnished by us, or to units which have been altered, modified or repaired without authorization from Fisher Manufacturing Company.

STEP BY STEP PROCEDURES

To obtain warranty servicing you should:

1. Contact Fisher Manufacturing Company for warranty service within thirty (30) days after defective product or part is discovered. Fisher Manufacturing Company may be consulted regarding warranty service at the following address and phone numbers.
2. Arrange for the delivery of the product or part to Fisher Manufacturing Company. Products shipped to Fisher must be insured and properly packed, preferably in the original carton, and a letter explaining the defect. Also, a copy of the bill of sale or other proof of purchase must be enclosed. You must pay all transportation and insurance charges.

FISHER MANUFACTURING COMPANY

PO BOX 60
TULARE, CA 9327

PHONE: (800)421-6162
FAX: (800)832-8238

THESE WARRANTIES AND REMEDIES ARE IN LIEU OF ALL OTHER WARRANTIES EXPRESSED, IMPLIED, OR STATUTORY. ALL OTHER OBLIGATIONS OR LIABILITIES (INCLUDING NEGLIGENCE) OF FISHER MANUFACTURING COMPANY. ALL IMPLIED WARRANTIES OF MERCHANT ABILITY AND FITNESS FOR A PARTICULAR PURPOSE WHICH EXCEED THE OBLIGATIONS AND TIME PERIODS STATED IN THE WARRANTIES ARE HEREBY DISCLAIMED AND EXCLUDED. Some states do not allow limitations on how long an implied warranty lasts, so the above information may not apply to you. IN NO EVENT SHALL FISHER MANUFACTURING COMPANY BE LIABLE FOR CONSEQUENTIAL OR INCIDENTAL DAMAGES. Some states do not allow the exclusion or limitation of incidental or consequential damages, so the above limit on or exclusion may not apply to you.

No person, agent, distributor, dealer, service station or company is authorized to change, modify, or extend the terms of these warranties in any manner whatsoever. The time within which action must be commenced to enforce any obligation of Fisher Manufacturing Company arising under this warranty or any implied warranty, or under an statute, or law of the United States or any state thereof, is hereby limited to one year from the date of the accrual of the cause of action. This warranty gives you specific legal rights, and you may also have other rights, which may vary, from state to state.

P.O. BOX 60 – TULARE, CA 93275-0060 | 1900 S. "O" STREET – TULARE, CA 93274-6850
PH (800) 421-6162 FAX (800) 832-8238
customer@fisherfaucets.com | www.fisherfaucets.com

WE BELIEVE IN

Fisher is a world leader in commercial plumbing equipment, as well as an enthusiastic supporter of causes which benefit the world.



THE CULINARY INSTITUTE OF AMERICA

We've Pledged Our Support Culinary Institute of America

Fisher Manufacturing is supporting today's top culinary students and investing in the education of our country's future chefs. That's why we've partnered with the Culinary Institute of America's to provide an annual scholarship for the next five years. Fisher is very proud to provide financial support to these deserving students.



CHARITY WATER

Fisher Manufacturing Helps Fund a Life-Giving Water Project in Ethiopia

Fisher Manufacturing has partnered with Charity: Water to build a well in Ethiopia, where is estimated that some 61 million people lack access to safe water, and where many walk more than three hours to collect it. Fisher believes in bringing clean, safe drinking water to people in developing countries.



DIGDEEP

We've Pledged Our Support DIGDEEP

Fisher Manufacturing has partnered with DIGDEEP and believes in bringing clean running water to the families who need it most. DIGDEEP is a human rights nonprofit organization dedicated to ensuring that every American has clean, running water forever.



ABOUT FISHER

Since 1936, Fisher Manufacturing has been dedicated to providing its customers with the most advanced commercial plumbing systems available. For three generations the Fisher Family has adhered to a strict **dedication of consistent performance, product dependability** and **overall value**. You know that you've installed the best when you install Fisher!

Fisher hardware is manufactured with a standardization of internal mechanisms. All chrome plating is triple plated - copper, nickel, and chrome - for durability. Every fixture we make is rigorously tested in both our modern in-house testing center and in actual field situations under extreme conditions.

Before we make our products available, every detail is thoroughly checked and re-checked, and must pass each and every test so you get proven performance...**Guaranteed!**

We invite you to explore our company, family of brass and stainless steel products, and technical support information for a more in-depth look at why Fisher Manufacturing is the world's leader in commercial plumbing equipment and hardware specialties.



FISHER 5 SOLUTIONS

ULTRA SPRAY VALVE



Guaranteed for 1 Million Cycles

EZ INSTALL ADAPTERS



CHEM TEE



Flush mount 3/8" NPT plug included
 Chemical port connection for speedy installation and reduced labor

DRAINING

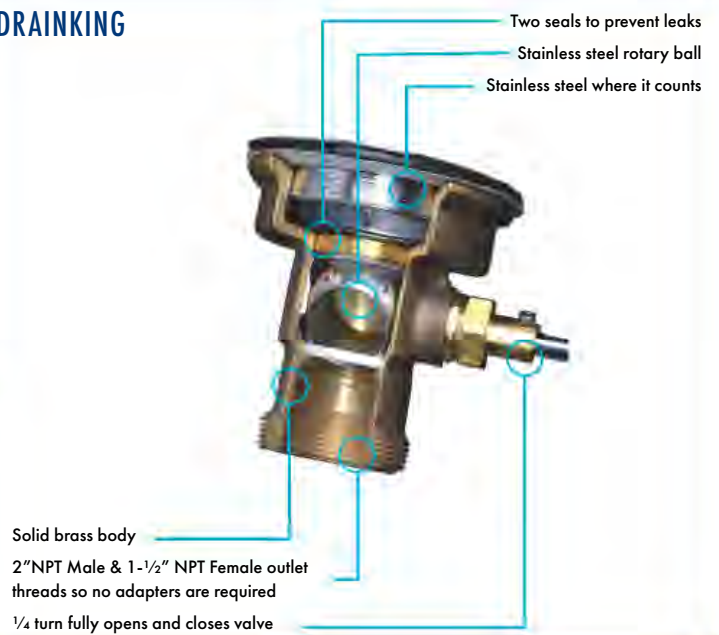

3-PLY HOSE

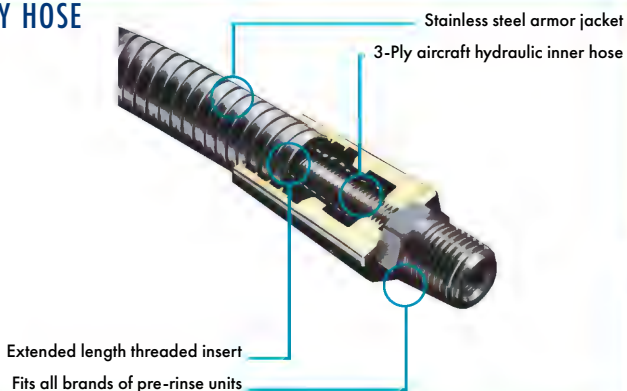

1/2" KITCHEN FAUCETS - CERAMIC

The new Fisher Ceramic Faucet line leads the industry in quality, reliability, and cost savings for the owners. They set new standard for the industry, and exceed customer expectations in multiple markets ranging from restaurants and bars, to education, healthcare, grocery and hospitality. Fisher now has a 4 year warranty on Ceramic faucets.

Featuring a lifetime warranty on ceramic disk stems.

SWIVEL/RIGID OUTLET

No need for extra adapters. Gives owners flexibility to choose a swivel or rigid option.

TWO O-RINGS
Ensures sealing.

INTERNATIONALLY COLOR CODED IDENTIFICATION BUTTONS ON HANDLES
Hot (red) and cold (blue) for safety.

STEM IDENTIFICATION
Stems can be identified with out removing the cartridges. Visibly marked RTC & LTC for (Right Turn Close & Left Turn Close)

INTERNAL CARTRIDGE STOPS
Larger internal cartridges stops than the competition absorbs more force.

AERATOR
2.2 GPM water saving aerator. Other GPM aerators available.

CERAMIC SHUT OFF
Non-wearing rubber parts. 1/4" turn open & close. Quieter with smoother operation.

BRASS BODY
High polished nickel chromium finish allows for easy cleaning and added durability. All new body designs.

LASER ENGRAVED
Easily identify Fisher faucets with new ceramic disk stems by laser-engraved Fisher logo.

LARGE OPENING
The unrestricted flow of the cartridge is fastest in the industry.

CHECK VALVES IN CARTRIDGE
Control valves operate as both check & swivel stems.

SPOUT CHOICES



Swing Spout



Gooseneck Swivel/Rigid

HANDLE TYPES

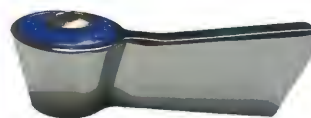

Lever



Wrist



8" BACKSPLASH SINK FAUCETS WITH LEVER HANDLES

PART		DESCRIPTION
13230		8" BACKSPLASH W/ 6" SWING SPOUT
13260		8" BACKSPLASH W/ 12" SWING SPOUT
64730		8" BACKSPLASH W/ 6" SWING SPOUT & EZ INSTALL ADAPTERS
64760		8" BACKSPLASH W/ 12" SWING SPOUT & EZ INSTALL ADAPTERS
ACCESSORIES		
3000-0003		07" DOUBLE JOINTED SPOUT
64211		CLOSE ELBOWS (2 EACH)
64351		SUPPLY LINES 1/2" F X 1/2" M X 36" LONG 2 EACH (REQUIRES CLOSE ELBOWS)



8" DECK SINK FAUCETS WITH LEVER HANDLES

PART		DESCRIPTION
33100		8" DECK W/ 6" SWING SPOUT
33130		8" DECK W/ 12" SWING SPOUT
ACCESSORIES		
75625		SUPPLY LINES 1/2" F X 1/2" F X 36" LONG (2 EACH)
3000-0003		07" DOUBLE JOINTED SPOUT



8" ADJ. WALL SINK FAUCETS WITH LEVER HANDLES

PART		DESCRIPTION
32500		8" ADJ. WALL W/ 6" SWING SPOUT
32530		8" ADJ. WALL W/ 12" SWING SPOUT
ACCESSORIES		
3000-0003		07" DOUBLE JOINTED SPOUT
64238		BACKSPLASH MOUNTING CLOSE NIPPLES 1/2" (2 EACH)
64211		CLOSE ELBOWS 1/2" 2 EACH (REQUIRES BACKSPLASH MOUNTING NIPPLES)
64351		SUPPLY LINES 1/2" F X 1/2" M X 36" LONG 2 EACH (REQUIRES CLOSE ELBOWS)



DUAL DECK SINK FAUCETS WITH LEVER HANDLES

PART		DESCRIPTION
31100		DUAL DECK W/ 6" SWING SPOUT
31130		DUAL DECK W/ 12" SWING SPOUT
ACCESSORIES		
3000-0003		07" DOUBLE JOINTED SPOUT
75962		SINGLE DECK DUAL CONTROL MOUNTING KIT HOSES



CHINESE RANGE WITH LEVER HANDLE

PART		DESCRIPTION
91190		CHINESE RANGE W/ 12" SWING SPOUT
ACCESSORIES		
3000-0003		07" DOUBLE JOINTED SPOUT
2400-2103		CLOSE ELBOW 1/2"
10006		SUPPLY LINES 1/2" F X 1/2" M X 36" LONG (REQUIRES CLOSE ELBOW)



4" BACKSPLASH SINK FAUCETS WITH LEVER HANDLES

PART	DESCRIPTION
36100	4" BACKSPLASH W/ 6" SWING SPOUT
36130	4" BACKSPLASH W/ 12" SWING SPOUT
ACCESSORIES	
3000-0003	07" DOUBLE JOINTED SPOUT
64211	CLOSE ELBOWS 1/2" (2 EACH)
64351	SUPPLY LINES 1/2F X 1/2M X 36" LONG 2 EACH (REQUIRES CLOSE ELBOWS)

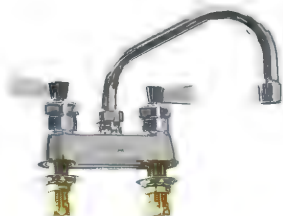

4" DECK SINK FAUCETS WITH LEVER HANDLES

PART	DESCRIPTION
35100	4" DECK W/ 6" SWING SPOUT
35130	4" DECK W/ 12" SWING SPOUT
ACCESSORIES	
3000-0003	07" DOUBLE JOINTED SPOUT
75625	SUPPLY LINES 1/2F X 1/2F X 36" LONG (2 EACH)



4" DECK SINK FAUCETS WITH WRIST HANDLES

PART	DESCRIPTION
91540	4" DECK W/ 6" SWING SPOUT
ACCESSORIES	
3000-0003	07" DOUBLE JOINTED SPOUT
75625	SUPPLY LINES 1/2F X 1/2F X 36" LONG (2 EACH)



SINGLE WALL/BACKSPLASH SINK FAUCETS WITH LEVER HANDLE

PART	DESCRIPTION
37100	SINGLE WALL/BACKSPLASH W/ 6" SWING SPOUT
37130	SINGLE WALL/BACKSPLASH W/ 12" SWING SPOUT
ACCESSORIES	
3000-0003	07" DOUBLE JOINTED SPOUT
2400-2103	CLOSE ELBOW 1/2"
10006	SUPPLY LINES 1/2F X 1/2M X 36" LONG (REQUIRES CLOSE ELBOW)

*INCLUDES NIPPLE FOR BACKSPLASH MOUNTING



SINGLE DECK SINK FAUCETS WITH LEVER HANDLE

PART	DESCRIPTION
30100	SINGLE DECK W/ 6" SWING SPOUT
30130	SINGLE DECK W/ 12" SWING SPOUT
ACCESSORIES	
3000-0003	07" DOUBLE JOINTED SPOUT
10022	SUPPLY LINES 1/2F X 1/2F X 36" LONG



CHINESE RANGE FAUCET WITH LEVER HANDLE

PART	DESCRIPTION
56000	CHINESE RANGE W/ 12" SWING SPOUT
ACCESSORIES	
3000-0003	07" DOUBLE JOINTED SPOUT
2400-2103	CLOSE ELBOW 1/2"
10006	SUPPLY LINES 1/2F X 1/2F X 36" LONG (REQUIRES CLOSE ELBOW)



4" DECK BAR & HAND SINK FAUCETS WITH LEVER HANDLES

PART	DESCRIPTION
35250	4" DECK W/ 6" SWIVEL / RIGID GOOSENECK SPOUT
35150	4" DECK W/ 12" SWIVEL / RIGID GOOSENECK SPOUT
ACCESSORIES	
75625	SUPPLY LINES 1/2" F X 1/2" F X 36" LONG (2 EACH)



4" DECK BAR & HAND SINK FAUCETS WITH WRIST HANDLES

PART	DESCRIPTION
84800	4" DECK W/ 6" SWIVEL / RIGID GOOSENECK SPOUT
44600	4" DECK W/ 12" SWIVEL / RIGID GOOSENECK SPOUT
ACCESSORIES	
75625	SUPPLY LINES 1/2" F X 1/2" F X 36" LONG (2 EACH)



4" BACKSPASH BAR & HAND SINK FAUCETS WITH LEVER HANDLES

PART	DESCRIPTION
19960	4" BACKSPASH W/ 6" SWIVEL / RIGID GOOSENECK SPOUT
36150	4" BACKSPASH W/ 12" SWIVEL / RIGID GOOSENECK SPOUT
ACCESSORIES	
75625	SUPPLY LINES 1/2" F X 1/2" F X 36" LONG (2 EACH)



4" BACKSPASH BAR & HAND SINK FAUCETS WITH WRIST HANDLES

PART	DESCRIPTION
90470	4" BACKSPASH W/ 6" SWIVEL / RIGID GOOSENECK SPOUT
80100	4" BACKSPASH W/ 12" SWIVEL / RIGID GOOSENECK SPOUT
ACCESSORIES	
75625	SUPPLY LINES 1/2" F X 1/2" F X 36" LONG (2 EACH)



8" BACKSPLASH BAR & HAND SINK FAUCETS WITH LEVER HANDLES

PART	DESCRIPTION
13220	8" BACKSPLASH W/ 6" SWIVEL / RIGID GOOSENECK SPOUT
13280	8" BACKSPLASH W/ 12" SWIVEL / RIGID GOOSENECK SPOUT
ACCESSORIES	
75625	SUPPLY LINES 1/2" X 1/2" X 36" LONG (2 EACH)



8" DECK BAR & HAND SINK FAUCETS WITH LEVER HANDLES

PART	DESCRIPTION
18210	8" DECK W/ 6" SWIVEL / RIGID GOOSENECK SPOUT
33150	8" DECK W/ 12" SWIVEL / RIGID GOOSENECK SPOUT
ACCESSORIES	
75625	SUPPLY LINES 1/2" X 1/2" X 36" LONG (2 EACH)



SINGLE DECK BAR & HAND SINK FAUCETS WITH LEVER HANDLE

PART	DESCRIPTION
18560	SINGLE DECK W/ 6" SWIVEL / RIGID GOOSENECK SPOUT
30150	SINGLE DECK W/ 12" SWIVEL / RIGID GOOSENECK SPOUT
ACCESSORIES	
10022	SUPPLY LINE 1/2" X 1/2" X 36" LONG



DUAL DECK BAR & HAND SINK FAUCETS WITH LEVER HANDLES

PART	DESCRIPTION
18720	DUAL DECK W/ 6" SWIVEL / RIGID GOOSENECK SPOUT
31150	DUAL DECK W/ 12" SWIVEL / RIGID GOOSENECK SPOUT
ACCESSORIES	
75962	SINGLE DECK DUAL CONTROL MOUNTING KIT HOSES



SINGLE WALL BAR & HAND SINK FAUCETS WITH LEVER HANDLE

PART	DESCRIPTION
20460	SINGLE WALL W/ 6" SWIVEL / RIGID GOOSENECK SPOUT
37150	SINGLE WALL W/ 12" SWIVEL / RIGID GOOSENECK SPOUT
ACCESSORIES	
10022	SUPPLY LINE 1/2" X 1/2" X 36" LONG



8" ADJ. POT FILLER FAUCETS WITH LEVER HANDLES

PART		DESCRIPTION
42300		8" ADJ. WALL W/ 12" POT FILLER SPOUT & 07" DOUBLE JOINTED SPOUT
42310		8" ADJ. WALL W/ 12" POT FILLER SPOUT & 12" DOUBLE JOINTED SPOUT
ACCESSORIES		
64238		BACKSPLASH 1/2" MOUNTING CLOSE NIPPLE (2 EACH)
64211		CLOSE ELBOWS 1/2" (REQUIRES BACKSPLASH MOUNTING NIPPLES) (2 EACH)
64351		SUPPLY LINES 1/2F X 1/2M X 36" LONG (REQUIRES CLOSE ELBOWS) (2 EACH)

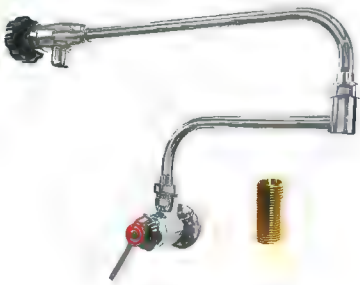

SINGLE WALL/BACKSPLASH POT FILLER FAUCETS WITH LEVER HANDLE

PART		DESCRIPTION
47300		SINGLE WALL / BACKSPLASH W/ 12" POT FILLER SPOUT & 07" DOUBLE JOINTED SPOUT
47310		SINGLE WALL / BACKSPLASH W/ 12" POT FILLER SPOUT & 12" DOUBLE JOINTED SPOUT
ACCESSORIES		
2400-2103		CLOSE ELBOW 1/2"
10006		SUPPLY LINES 1/2F X 1/2M X 36" LONG (REQUIRES CLOSE ELBOWS)

*INCLUDES NIPPLE FOR BACKSPLASH MOUNTING

WALL MOUNT FAUCET

1/2" NPT Female inlet. Distance can be varied from 7.5" to 8.5" c/c.

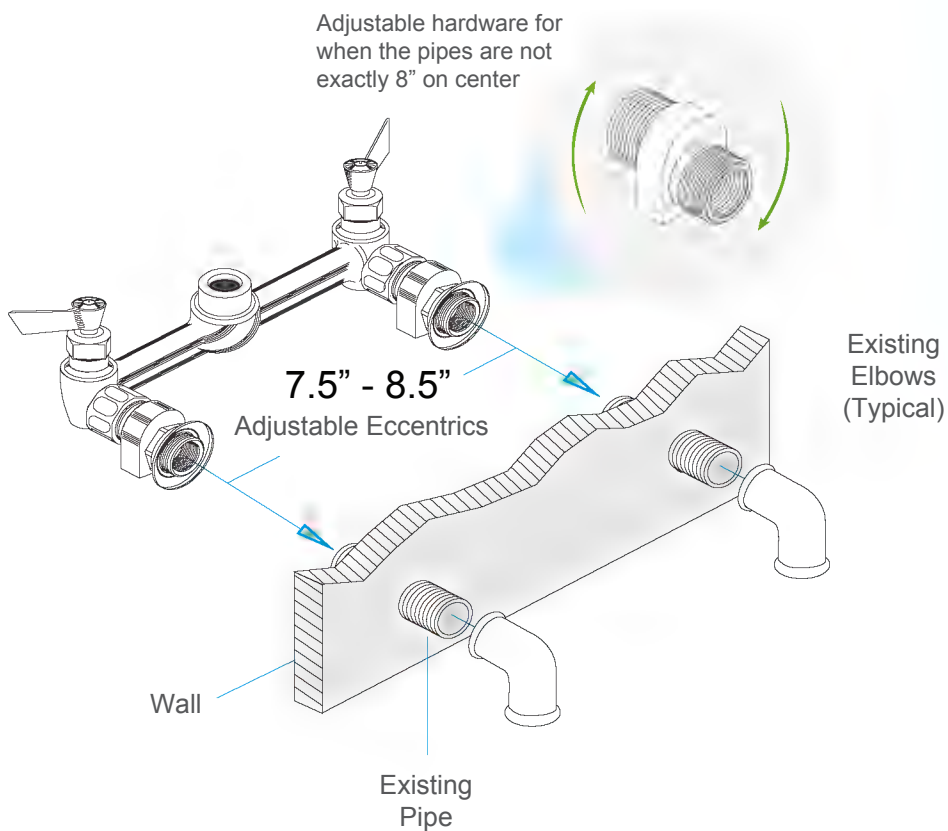

BACKSPLASH MOUNT FAUCET

1/2" NPT male inlet. Distance is fixed at 8" c/c.

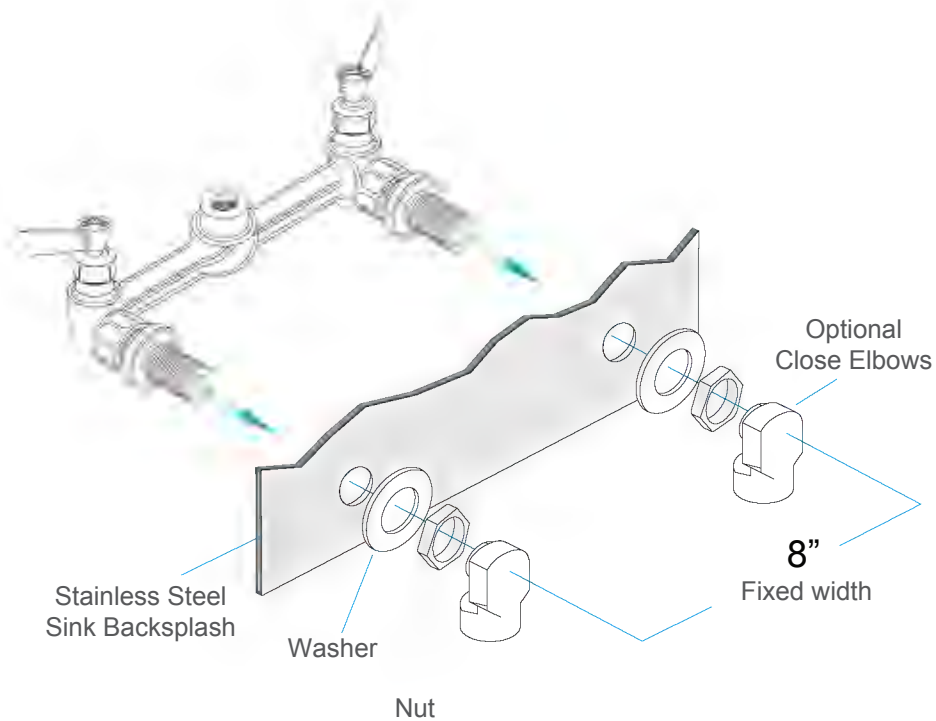



SINGLE WALL / BACKSPLASH SERVICE SINK FAUCETS WITH LEVER HANDLE & CROSS HANDLE

PART	DESCRIPTION
29550	SINGLE WALL / BACKSPLASH W/ 3" SERVICE SINK SPOUT
ACCESSORIES	
2400-2103	CLOSE ELBOW
10006	SUPPLY LINES 1/2" F X 1/2" M X 36" LONG (REQUIRES CLOSE ELBOWS)

*INCLUDES NIPPLE FOR BACKSPLASH MOUNTING



8" ADJ. WALL SERVICE SINK FAUCETS WITH LEVER HANDLES

PART	DESCRIPTION
24450	8" ADJ. WALL W/ 3" SERVICE SINK SPOUT
19820	8" ADJ. WALL W/ 3" SERVICE SINK SPOUT & EZ INSTALL ADAPTERS
ACCESSORIES	
64238	BACKSPLASH MOUNTING CLOSE NIPPLE 1/2" (2 EACH)
64211	CLOSE ELBOWS 1/2" 2 EACH (REQUIRES BACKSPLASH MOUNTING NIPPLES)
64351	SUPPLY LINES 1/2" F X 1/2" M X 36" LONG 2 EACH (REQUIRES CLOSE ELBOWS)



8" ADJ. WALL SERVICE SINK FAUCETS WITH LEVER HANDLES

PART	DESCRIPTION
19790	8" ADJ. WALL W/ 6" SERVICE SINK SPOUT
82530	8" ADJ. WALL W/ 6" SERVICE SINK SPOUT & EZ INSTALL ADAPTERS
ACCESSORIES	
64238	BACKSPLASH MOUNTING CLOSE NIPPLE 1/2" (2 EACH)
64211	CLOSE ELBOWS 1/2" 2 EACH (REQUIRES BACKSPLASH MOUNTING NIPPLES)
64351	SUPPLY LINES 1/2" F X 1/2" M X 36" LONG 2 EACH (REQUIRES CLOSE ELBOWS)

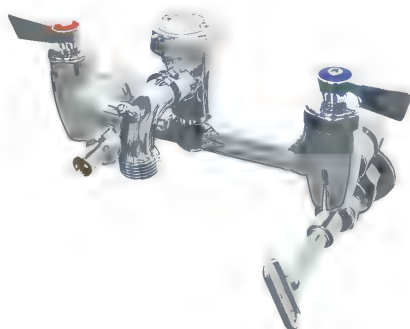

8" ADJ. WALL W/ STOPS SERVICE SINK FAUCETS WITH LEVER HANDLES

PART	DESCRIPTION
24530	8" ADJ. WALL W/ STOPS W/ 3" SERVICE SINK SPOUT
ACCESSORIES	
64238	BACKSPLASH MOUNTING CLOSE NIPPLE 1/2" (2 EACH)
64211	CLOSE ELBOWS 1/2" 2 EACH (REQUIRES BACKSPLASH MOUNTING NIPPLES)
64351	SUPPLY LINES 1/2" F X 1/2" M X 36" LONG 2 EACH (REQUIRES CLOSE ELBOWS)



8" ADJ. WALL W/ STOPS SERVICE SINK FAUCETS WITH LEVER HANDLES

PART	DESCRIPTION
82610	8" ADJ. WALL W/ STOPS W/ 6" SERVICE SINK SPOUT
ACCESSORIES	
64238	BACKSPLASH MOUNTING CLOSE NIPPLE 1/2" (2 EACH)
64211	CLOSE ELBOWS 1/2" 2 EACH (REQUIRES BACKSPLASH MOUNTING NIPPLES)
64351	SUPPLY LINES 1/2F X 1/2M X 36" LONG 2 EACH (REQUIRES CLOSE ELBOWS)



8" BACKSPLASH CONTROL VALVE WITH LEVER HANDLES

PART	DESCRIPTION
13150	8" BACKSPLASH CONTROL VALVE



8" BACKSPLASH CONTROL VALVE WITH LEVER HANDLES

PART	DESCRIPTION
63810	8" BACKSPLASH CONTROL VALVE WITH EZ INSTALL ADAPTERS



8" DECK CONTROL VALVE WITH LEVER HANDLES

PART	DESCRIPTION
33000	8" DECK CONTROL VALVE



8" ADJ. WALL CONTROL VALVE WITH LEVER HANDLES

PART	DESCRIPTION
32000	8" ADJ. WALL CONTROL VALVE



8" ADJ. WALL WITH STOPS CONTROL VALVE WITH LEVER HANDLES

PART	DESCRIPTION
32010	8" ADJ. WALL WITH STOPS CONTROL VALVE



4" BACKSPLASH CONTROL VALVE WITH LEVER HANDLES

PART	DESCRIPTION
36000	4" BACKSPLASH CONTROL VALVE

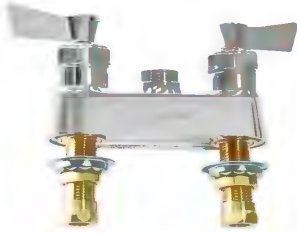

4" DECK CONTROL VALVE WITH LEVER HANDLES

PART	DESCRIPTION
35000	4" DECK CONTROL VALVE



DUAL DECK CONTROL VALVE WITH LEVER HANDLES

PART	DESCRIPTION
13060	DUAL DECK CONTROL VALVE



SINGLE WALL / BACKSPLASH CONTROL VALVE WITH LEVER HANDLE

PART	DESCRIPTION
37000	SINGLE WALL / BACKSPLASH CONTROL VALVE

*INCLUDES NIPPLE FOR BACKSPLASH MOUNTING



SINGLE DECK CONTROL VALVE WITH LEVER HANDLE

PART	DESCRIPTION
12810	SINGLE DECK CONTROL VALVE



CHINESE RANGE CONTROL VALVE WITH LEVER HANDLE

PART	DESCRIPTION
47550	CHINESE RANGE CONTROL VALVE 1/2 X 7 5/8 NIPPLE



CHINESE RANGE CONTROL VALVE WITH LEVER HANDLE

PART	DESCRIPTION
15010	CHINESE RANGE CONTROL VALVE 1/2 X 3 5/8 NIPPLE



1/2" SWING SPOUTS

PART	DESCRIPTION
3960	6" SWING SPOUT
3961	8" SWING SPOUT
3962	10" SWING SPOUT
3963	12" SWING SPOUT
3964	14" SWING SPOUT
3967	16" SWING SPOUT

*SPOUT REQUIRE CONTROL VALVES WITH SWIVEL OUTLET AND SWIVEL STEMS



1/2" SWIVEL DOUBLE JOINT

PART	DESCRIPTION
3000-0003	7" SWIVEL DOUBLE JOINT
4000-0002	13" SWIVEL DOUBLE JOINT

*DJ'S REQUIRE CONTROL VALVES WITH SWIVEL OUTLETS



1/2" SWIVEL GOOSENECK SPOUTS

PART	DESCRIPTION
3968	6" SWIVEL GOOSENECK SPOUT
3965	12" SWIVEL GOOSENECK SPOUT

*SPOUT REQUIRE CONTROL VALVES WITH SWIVEL OUTLET AND SWIVEL STEMS



1/2" RIGID GOOSENECK SPOUTS

PART	DESCRIPTION
3969	6" RIGID GOOSENECK SPOUT
3966	12" RIGID GOOSENECK SPOUT

*SPOUT REQUIRE CONTROL VALVES WITH RIGID OUTLET AND SWIVEL STEMS



CONTROL SPOUT WITH INSULATED KNOB

PART	DESCRIPTION
40000	11" SWIVEL CONTROL SPOUT



1/2" CERAMIC STEMS

CERAMIC	DESCRIPTION
75959	STEM 1/2" CERAMIC DISK RIGHT HAND REPLACEMENT
75958	STEM 1/2" CERAMIC DISK LEFT HAND REPLACEMENT

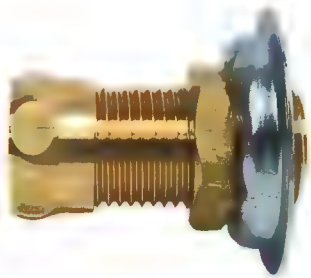

BACKSPLASH MOUNTING NIPPLES FOR WALL FAUCETS

PART	DESCRIPTION
64238	BACKSPLASH MOUNTING CLOSE NIPPLES 1/2" FOR WALL FAUCETS (2 EACH)



ELBOWS FOR WALL & BACKSPLASH FAUCETS

PART	DESCRIPTION
2400-2103	CLOSE ELBOWS FOR BACKSPLASH CONTROL VALVES
64211	CLOSE ELBOWS FOR BACKSPLASH CONTROL VALVES (2 EACH)



SUPPLY LINES

PART	DESCRIPTION
10006	SUPPLY LINE 1/2" FEMALE X 1/2" MALE X 36" LONG FOR BACKSPLASH MOUNTED CONTROL VALVES WITH ELBOWS
64351	SUPPLY LINE 1/2" FEMALE X 1/2" MALE X 36" LONG FOR BACKSPLASH MOUNTED CONTROL VALVES WITH ELBOWS (2 EACH)
10022	SUPPLY LINE 1/2" FEMALE X 1/2" FEMALE X 36" LONG FOR DECK MOUNT CONTROL VALVES AND BASES
75625	SUPPLY LINE 1/2" FEMALE X 1/2" FEMALE X 36" LONG FOR DECK MOUNT CONTROL VALVES (2 EACH)

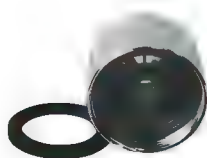

SPOUT END ATTACHMENTS FOR SWING AND GOOSENECK SPOUTS

PART	DESCRIPTION
75801	FULL FLOW AERATOR SPOUT END



KETTLE FILLER RISERS

PART	DESCRIPTION
72747	2-1/2" RISER
72748	4" RISER
2927-4302	12" RISER
2927-4303	16" RISER
2927-4300	21" RISER

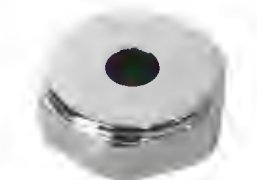
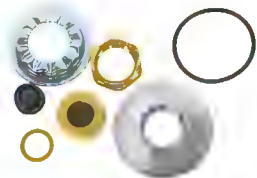

O-RING FOR SINGLE DECK FAUCET

PART	DESCRIPTION
75963	O-RING

INSTALL KIT FOR 8" DECK FAUCET

PART	DESCRIPTION
75961	INSTALL KIT

INSTALL KIT FOR SINGLE DECK DUAL FAUCET

PART	DESCRIPTION
75962	INSTALL KIT

O-RING FOR 8" DECK FAUCET

PART	DESCRIPTION
75960	O-RING

KIT FOR PRE-RINSE UNIT

PART	DESCRIPTION
75964	PRE-RINSE KIT

BIBB CAP

PART	DESCRIPTION
75957	BIBB CAP

1/2" PRE-RINSE UNITS - CERAMIC

The new line of Fisher Ceramic Pre-rinse units save thousands of dollars in utility bills by equipping your commercial kitchen with one of our innovative Fisher Pre-Rinse Units. Each unit features the water saving Ultra Spray Valve Plus and new Chemical Tee. Fisher now offers a 4 year warranty on ceramic units.

Featuring a lifetime warranty on ceramic stems.

CHECK OUT THESE PRE-RINSE FEATURES:



EXTRA COIL DENSITY

Provides enhanced protection against hose and armor fatigue at critical points.

UNIVERSAL DESIGN

Fits ALL brands.

MULTI-COIL DESIGN

Enhanced at both ends.

CHEM TEE

Less obstruction - no need for a longer hose. The flush mount 3/8" NPT plug is included. The chemical port connection ensures easy installation for a reduced cost in labor.



WALL BRACKET

Secures the pre-rinse unit to the wall with 3 set screws to provide reinforcement and stability while also being adjustable.



INTERNATIONALLY COLOR CODED IDENTIFICATION BUTTONS ON HANDLES

Hot (red) and cold (blue) for safety.

BRASS BODY

The high polished nickel chromium finish allows for easy cleaning and added durability. All new body designs.

LASER ENGRAVED

Easily identify Fisher faucets with new ceramic disk stems by laser-engraved Fisher logo.

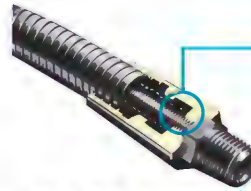

3-PLY AIRCRAFT HYDRAULIC INNER HOSE

Last three times longer than the competition.

EXTENDED LENGTH THREADED INSERT

Securely seals the interior hose.

STAINLESS STEEL ARMOR JACKET

Relieves tension and abrasion on the interior hose to provide a longer service life.



INSULATED HANDLE

Heat resistant brass-alloy handle rubber dipped for added protection.

ULTRA SPRAY VALVE STANDARD PROTECTIVE FULL-SURROUNDING DISH GUARD BUMPER

Eliminates leaking.

PTFE-DISC FOR SMOOTHER ACTION

1.15 GPM Knife Edge spray nozzle

Guaranteed for 1 million cycles!

HEAVY DUTY LIFT PIN

The two o-rings ensure a proper seal.

FITS ALL BRANDS OF HOSES

STEM IDENTIFICATION

Stems can be identified without removing the cartridges. Visibly marked RTC & LTC for (Right Turn Close & Left Turn Close)

INTERNAL CARTRIDGE STOPS

Larger internal cartridge stops than the competition absorbs more force.

CERAMIC SHUT OFF

Non-wearing rubber parts. 1/4" turn open & close. Quieter with smoother operation.

CHECK VALVES IN CARTRIDGE

Control valves operate as both check & swivel stems.

LARGER OPENING

The unrestricted flow of the cartridge is the fastest in the industry.

SWIVEL STYLE OPTIONS



SWIVEL STYLE

The long swivel arm provides maximum reach and a superior range of motion.

PRE-RINSE CRITICAL POINTS

Overall height from base of faucet

Spring Style - 38"

Swivel Style - 38"

Mini Style - 22 3/8"

Distance from bottom of spray valve to bottom of faucet:

Spring Style - 12"

Swivel Style - 7"

Mini Style - 7 5/8"



8" BACKSPLASH SPRING STYLE PRE-RINSE

PART	DESCRIPTION
13330	8" BACKSPLASH SPRING STYLE PRE-RINSE & ULTRA SPRAY PLUS
64790	8" BACKSPLASH SPRING STYLE PRE-RINSE & ULTRA SPRAY PLUS WITH EZ INSTALL ADAPTERS
ACCESSORIES	
64211	CLOSE ELBOWS (2 EACH)
64351	SUPPLY LINES 1/2" F X 1/2" M X 36" LONG (2 EACH. REQUIRES CLOSE ELBOWS)
2949-9001	SPRAY VALVE BRUSH
2932-0002	DUAL CHECK VACUUM BREAKER 3/4"-14 FEMALE X 3/4"-14 MALE



8" BACKSPLASH SPRING STYLE PRE-RINSE W/ ADD ON FAUCET

PART	DESCRIPTION
34430	8" BACKSPLASH SPRING STYLE PRE-RINSE W/ ADD-ON FAUCET, ULTRA SPRAY VALVE PLUS & 6" SWING SPOUT
34410	8" BACKSPLASH SPRING STYLE PRE-RINSE W/ ADD-ON FAUCET, ULTRA SPRAY VALVE PLUS & 12" SWING SPOUT
48880	8" BACKSPLASH SPRING STYLE PRE-RINSE W/ ADD-ON FAUCET, ULTRA SPRAY VALVE PLUS & 6" SWING SPOUT WITH EZ INSTALL ADAPTERS
48910	8" BACKSPLASH SPRING STYLE PRE-RINSE W/ ADD-ON FAUCET, ULTRA SPRAY VALVE PLUS & 12" SWING SPOUT WITH EZ INSTALL ADAPTERS
ACCESSORIES	
64211	CLOSE ELBOWS (2 EACH)
64351	SUPPLY LINES 1/2" F X 1/2" M X 36" LONG (2 EACH. REQUIRES CLOSE ELBOWS)
2949-9001	SPRAY VALVE BRUSH
2932-0002	DUAL CHECK VACUUM BREAKER 3/4"-14 FEMALE X 3/4"-14 MALE



8" DECK SPRING STYLE PRE-RINSE

PART	DESCRIPTION
23100	8" DECK SPRING STYLE PRE-RINSE & ULTRA SPRAY PLUS
ACCESSORIES	
75625	SUPPLY LINES 1/2" F X 1/2" F X 36" LONG (2 EACH)
2949-9001	SPRAY VALVE BRUSH
2932-0002	DUAL CHECK VACUUM BREAKER 3/4"-14 FEMALE X 3/4"-14 MALE



8" DECK SPRING STYLE PRE-RINSE W/ ADD ON FAUCET

PART	DESCRIPTION
34220	8" DECK SPRING STYLE PRE-RINSE W/ ADD-ON FAUCET, ULTRA SPRAY VALVE PLUS & 6" SWING SPOUT
34260	8" DECK SPRING STYLE PRE-RINSE W/ ADD-ON FAUCET, ULTRA SPRAY VALVE PLUS & 12" SWING SPOUT
ACCESSORIES	
75625	SUPPLY LINES 1/2" F X 1/2" F X 36" LONG (2 EACH)
2949-9001	SPRAY VALVE BRUSH
2932-0002	DUAL CHECK VACUUM BREAKER 3/4"-14 FEMALE X 3/4"-14 MALE



8" ADJ. WALL SPRING STYLE PRE-RINSE

PART	DESCRIPTION
22100	8" ADJ. WALL SPRING STYLE PRE-RINSE & ULTRA SPRAY PLUS
ACCESSORIES	
64238	BACKSPLASH MOUNTING NIPPLES (2 EACH)
64211	CLOSE ELBOWS (2 EACH. REQUIRES BACKSPLASH MOUNTING NIPPLES)
64351	SUPPLY LINES 1/2" F X 1/2" M X 36" LONG (2 EACH. REQUIRES CLOSE ELBOWS)
2949-9001	SPRAY VALVE BRUSH
2932-0002	DUAL CHECK VACUUM BREAKER 3/4"-14 FEMALE X 3/4"-14 MALE



8" ADJ. WALL SPRING STYLE PRE-RINSE W/ ADD ON FAUCET

PART	DESCRIPTION
34350	8" ADJ. WALL SPRING STYLE PRE-RINSE W/ ADD-ON FAUCET, ULTRA SPRAY VALVE PLUS & 6" SWING SPOUT
34390	8" ADJ. WALL SPRING STYLE PRE-RINSE W/ ADD-ON FAUCET, ULTRA SPRAY VALVE PLUS & 12" SWING SPOUT
ACCESSORIES	
64238	BACKSPLASH MOUNTING NIPPLES (2 EACH)
64211	CLOSE ELBOWS (2 EACH. REQUIRES BACKSPLASH MOUNTING NIPPLES)
64351	SUPPLY LINES 1/2" F X 1/2" M X 36" LONG (2 EACH. REQUIRES CLOSE ELBOWS)
2949-9001	SPRAY VALVE BRUSH
2932-0002	DUAL CHECK VACUUM BREAKER 3/4"-14 FEMALE X 3/4"-14 MALE



DUAL DECK SPRING STYLE PRE-RINSE

PART	DESCRIPTION
21100	DUAL DECK SPRING STYLE PRE-RINSE & ULTRA SPRAY PLUS
ACCESSORIES	
2949-9001	SPRAY VALVE BRUSH
2932-0002	DUAL CHECK VACUUM BREAKER 3/4"-14 FEMALE X 3/4"-14 MALE



DUAL DECK SPRING STYLE PRE-RINSE W/ ADD ON FAUCET

PART	DESCRIPTION
34160	DUAL DECK SPRING STYLE PRE-RINSE W/ ADD-ON FAUCET, ULTRA SPRAY VALVE PLUS & 6" SWING SPOUT
34190	DUAL DECK SPRING STYLE PRE-RINSE W/ ADD-ON FAUCET, ULTRA SPRAY VALVE PLUS & 12" SWING SPOUT
ACCESSORIES	
2949-9001	SPRAY VALVE BRUSH
2932-0002	DUAL CHECK VACUUM BREAKER 3/4"-14 FEMALE X 3/4"-14 MALE



8" BACKSPASH CONTROL VALVE

PART	DESCRIPTION
13150	Swivel/Rigid Outlet / Ceramic Stems



8" DECK CONTROL VALVE

PART	DESCRIPTION
33000	Swivel/Rigid Outlet / Ceramic Stems



8" ADJ. WALL CONTROL VALVE

PART	DESCRIPTION
32000	Swivel/Rigid Outlet / Ceramic Stems



8" ADJ. WALL WITH STOPS CONTROL VALVE

PART	DESCRIPTION
32010	Swivel/Rigid Outlet / Ceramic Stems



4" BACKSPASH CONTROL VALVE

PART	DESCRIPTION
36000	Swivel/Rigid Outlet / Ceramic Stems

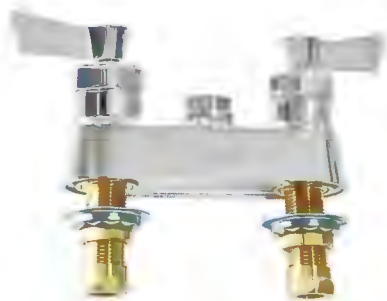

4" DECK CONTROL VALVE

PART	DESCRIPTION
35000	Swivel/Rigid Outlet / Ceramic Stems



DUAL DECK CONTROL VALVE

PART	DESCRIPTION
13060	Swivel/Rigid Outlet / Ceramic Stems



SINGLE WALL / BACKSPASH CONTROL VALVE

PART	DESCRIPTION
37000	Swivel/Rigid Outlet / Ceramic Stems



SINGLE DECK CONTROL VALVE

PART	DESCRIPTION
12810	Swivel/Rigid Outlet / Ceramic Stems



PRE-RINSE SPRING STYLE SUB-ASSEMBLY

PART	DESCRIPTION
97993	SPRING STYLE SUB-ASSEMBLY W/ ULTRA SPRAY VALVE & 16" RISER FOR PRE-RINSES WITH ADD-ON FAUCETS
2928	SPRING STYLE SUB-ASSEMBLY W/ ULTRA SPRAY VALVE & 21" RISER FOR PRE-RINSES WITHOUT ADD-ON FAUCETS
75594	SPRING STYLE SUB-ASSEMBLY W/ ULTRA SPRAY VALVE 7 & 16" RISER FOR PRE-RINSES WITH ADD-ON FAUCETS
75595	SPRING STYLE SUB-ASSEMBLY W/ ULTRA SPRAY VALVE 7 & 21" RISER FOR PRE-RINSES WITHOUT ADD-ON FAUCETS

* INCLUDES ADAPTER TO ASSEMBLE TO T&S CONTROL VALVES

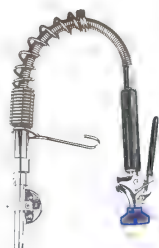

PRE-RINSE MINI SPRING STYLE SUB-ASSEMBLY

PART	DESCRIPTION
75410	MINI SPRING STYLE SUB-ASSEMBLY W/ ULTRA SPRAY VALVE & 4" RISER FOR PRE-RINSES WITH ADD-ON FAUCETS
75408	MINI SPRING STYLE SUB-ASSEMBLY W/ ULTRA SPRAY VALVE & 10" RISER FOR PRE-RINSES WITHOUT ADD-ON FAUCETS
75598	MINI SPRING STYLE SUB-ASSEMBLY W/ ULTRA SPRAY VALVE 7 & 4" RISER FOR PRE-RINSES WITH ADD-ON FAUCETS
75599	MINI SPRING STYLE SUB-ASSEMBLY W/ ULTRA SPRAY VALVE 7 & 10" RISER FOR PRE-RINSES WITHOUT ADD-ON FAUCETS

* INCLUDES ADAPTER TO ASSEMBLE TO T&S CONTROL VALVES



PRE-RINSE SWIVEL STYLE SUB-ASSEMBLY

PART	DESCRIPTION
2211-0000	SWIVEL STYLE SUB-ASSEMBLY W/ ULTRA SPRAY VALVE & 31" RISER FOR PRE-RINSES WITHOUT ADD-ON FAUCETS
75602	SWIVEL STYLE SUB-ASSEMBLY W/ ULTRA SPRAY VALVE 7 & 25" RISER FOR PRE-RINSES WITH ADD-ON FAUCETS
75603	SWIVEL STYLE SUB-ASSEMBLY W/ ULTRA SPRAY VALVE 7 & 31" RISER FOR PRE-RINSES WITHOUT ADD-ON FAUCETS

* INCLUDES ADAPTER TO ASSEMBLE TO T&S CONTROL VALVES



GLASS FILLER SPRING STYLE SUB-ASSEMBLY

PART	DESCRIPTION
75564	SPRING STYLE SUB-ASSEMBLY W/ GLASS FILLER VALVE & 16" RISER FOR GLASS FILLERS WITH ADD-ON FAUCETS
75555	SPRING STYLE SUB-ASSEMBLY W/ GLASS FILLER VALVE & 21" RISER FOR GLASS FILLERS WITHOUT ADD-ON FAUCETS

* INCLUDES ADAPTER TO ASSEMBLE TO T&S CONTROL VALVES



1/2" CERAMIC DISK STEM

CERAMIC	DESCRIPTION
75959	STEM 1/2" CERAMIC DISK RIGHT HAND REPLACEMENT
75958	STEM 1/2" CERAMIC DISK LEFT HAND REPLACEMENT

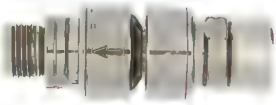

DUAL CHECK VALVES & VACUUM BREAKERS

PART	DESCRIPTION
2932-0002	DUAL CHECK VACUUM BREAKER 3/4"-14 FEMALE X 3/4"-14 MALE

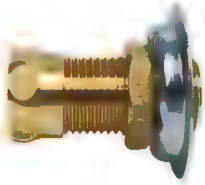

NIPPLES FOR ADJ. WALL PRE-RINSES

PART	DESCRIPTION
64238	NIPPLE FOR 1/2" ADJ. WALL PRE-RINSES 1/2" NPT MALE X 1/2" NPT MALE X 1 3/4" LONG W/ SLIP JOINT KIT (2 EACH)
2200-0000	NIPPLE FOR 1/2" ADJ WALL PRE-RINSES 1/2" NPT MALE X 1/2" MALE X 1 3/4" LONG W/ SLIP JOINT KIT



ELBOWS FOR ADJ. WALL W/ NIPPLE & BACKSPASH PRE-RINSE

PART	DESCRIPTION
2400-2103	ELBOWS FOR 1/2" WALL W/ NIPPLES & BACKSPASH PRE-RINSES 1/2" NPT FEMALE X 1/2" NPT FEMALE
64211	ELBOWS FOR 1/2" WALL W/ NIPPLES & BACKSPASH PRE-RINSES 1/2" NPT FEMALE X 1/2" NPT FEMALE (2 EACH)



SUPPLY LINES FOR 1/2" PRE-RINSE UNITS

PART	DESCRIPTION
10006	SUPPLY LINES FOR 1/2" PRE-RINSES 1/2" FEMALE X 1/2" MALE X 36" LONG
64351	SUPPLY LINES FOR 1/2" PRE-RINSES 1/2" FEMALE X 1/2" MALE X 36" LONG (2 EACH)
10022	SUPPLY LINES FOR 1/2" PRE-RINSES 1/2" FEMALE X 1/2" FEMALE X 36" LONG
75625	SUPPLY LINES FOR 1/2" PRE-RINSES 1/2" FEMALE X 1/2" FEMALE X 36" LONG (2 EACH)



SPRAY VALVE BRUSH

PART	DESCRIPTION
2949-9001	SPRAY VALVE BRUSH



1/2" SWING SPOUTS FOR ADD-ON FAUCET

PART	DESCRIPTION
3960	6" SWING SPOUT
3961	8" SWING SPOUT
3962	10" SWING SPOUT
3963	12" SWING SPOUT
3964	14" SWING SPOUT
3967	16" SWING SPOUT



ADD-ON FAUCETS

PART	DESCRIPTION
29060	ADD-ON FAUCET W/ 4" RISER W/ 6" SPOUT
29120	ADD-ON FAUCET W/ 4" RISER W/ 12" SPOUT
29010	ADD-ON FAUCET W/ 4" RISER LESS SPOUT



KIT FOR PRE-RINSE UNIT

PART	DESCRIPTION
75964	PRE-RINSE KIT



BIBB CAP

PART	DESCRIPTION
75957	BIBB CAP



O-RING FOR 8" DECK FAUCET

PART	DESCRIPTION
75960	O-RING



INSTALL KIT FOR SINGLE DECK DUAL FAUCET

PART	DESCRIPTION
75962	INSTALL KIT

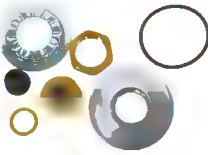

INSTALL KIT FOR 8" DECK

PART	DESCRIPTION
75961	INSTALL KIT



O-RING FOR SINGLE DECK FAUCET

PART	DESCRIPTION
75963	O-RING

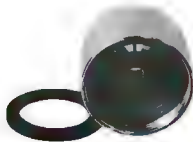

NEOSTRAHL FULL FLOW STREAM AERATOR

PART	DESCRIPTION
75801	NEOSTRAHL FULL FLOW STREAMAERATOR 55/64-27

1/2" POT FILLER HOSE, UTILITY SPRAY, & GLASS FILLER UNITS - CERAMIC

1/2" POT FILLER HOSE, UTILITY SPRAY, & GLASS FILLER UNITS - CERAMIC

Fisher's Kettle, Glass Fillers and Utility Sprays are now available with ceramic stems. The simple design on the Kettle, Glass Fillers and Utility Spray also gives you maximum mobility and allows you to get to even the hardest to reach places within your kitchen. They come with the options of a Swivel Adapter or Vacuum Breaker. Ideal for restaurants, healthcare facilities, grocery/retail facilities, hospitality facilities, and convenience stores. Fisher's ceramic products now come with a 4 year warranty.

Featuring a lifetime warranty on ceramic stems.

CHECK OUT THE FEATURES OF OUR 1/2" KETTLE FILLER:

WALL HOOK

Mounts to the wall to secure the pot filler valve when not in use so it is prevented from getting in the way.

Choose from POT FILLER VALVE

Heat resistant and guaranteed 1 Million cycles.

OR

GLASS FILLER VALVE

Designed to deliver maximum water flow 5.0 GPM with minimal utility costs. Comes with angled head for increased comfort during use.

UTILITY SPRAY

The 2.15 GPM shower head is Guaranteed for 1 Million Cycles.

INSULATED HANDLE

Heat resistant brass-alloy handle rubber dipped for added protection.

FOODGRADE HOSE

Ensures the taste of the food is not altered.

STAINLESS STEEL ARMOR JACKET

Relieves tension and abrasion on the interior hose to provide a longer service life.

EXTENDED LENGTH THREADED INSERT

Securely seals the interior hose.

AERATOR

Designed to deliver maximum water flow at 5 GPM with minimal utility costs.

LASER ENGRAVED

Easily identify Fisher faucets with new ceramic disk stems by laser-engraved Fisher logo.

SWIVEL HOSE ADAPTER 1/4" FEMALE OUTLET ATMOSPHERIC VACUUM BREAKER

The atmospheric vacuum breaker helps prevent both pollutants and contaminants from backflow-siphonage.

OR SWIVEL HOSE ADAPTER 1/4"

Provides a full 360 degree range of motion while also putting less stress on the hose connections.

BRASS BODY

The high polished nickel chromium finish allows for easy cleaning and added durability. All new body designs.

INTERNATIONALLY COLOR CODED IDENTIFICATION BUTTONS ON HANDLES

Hot (red) and cold (blue) for safety.

BACKFLOW PREVENTER

Prevents backflow caused by backflow-siphonage or back pressure.

STEM IDENTIFICATION

Stems can be identified with out removing the cartridges. Visibly marked RTC & LTC for (Right Turn Close & Left Turn Close)

INTERNAL CARTRIDGE STOPS

Larger internal cartridge stops than the competition absorbs more water force.

CERAMIC SHUT OFF

Non-wearing rubber parts. 1/4" turn open & close. Quieter with smoother operation.

CHECK VALVES IN CARTRIDGE

Control valves operate as both check & swivel stems.

LARGER OPENING

The unrestricted flow of the cartridge is fastest in the industry.



8" ADJ. WALL POT FILLER HOSE UNITS

PART	DESCRIPTION
22400	8" ADJ. WALL W/ SWIVEL ELBOW VACUUM BREAKER & 60" HOSE
ACCESSORIES	
64238	BACKSPLASH MOUNTING NIPPLES (2 EACH)
64211	CLOSE ELBOWS (2 EACH. REQUIRES BACKSPLASH MOUNTING NIPPLES)
64351	SUPPLY LINES 1/2" F X 1/2" M X 36" LONG (2 EACH. REQUIRES CLOSE ELBOWS)



8" ADJ. WALL POT FILLER HOSE UNITS

PART	DESCRIPTION
22500	8" ADJ. WALL W/ SWIVEL ELBOW & 60" HOSE
ACCESSORIES	
64238	BACKSPLASH MOUNTING NIPPLES (2 EACH)
64211	CLOSE ELBOWS (2 EACH. REQUIRES BACKSPLASH MOUNTING NIPPLES)
64351	SUPPLY LINES 1/2" F X 1/2" M X 36" LONG (2 EACH. REQUIRES CLOSE ELBOWS)
2542	DUAL CHECK VACUUM BREAKER 1/4" FEMALE X 1/4" MALE



SINGLE WALL / BACKSPLASH POT FILLER HOSE UNITS

PART	DESCRIPTION
27400	SINGLE WALL / BACKSPLASH W/ SWIVEL ELBOW VACUUM BREAKER & 60" HOSE
ACCESSORIES	
2400-2103	CLOSE ELBOWS
10006	SUPPLY LINES 1/2" F X 1/2" M X 36" LONG (2 EACH. REQUIRES CLOSE ELBOWS)



SINGLE WALL / BACKSPLASH POT FILLER HOSE UNITS

PART	DESCRIPTION
27500	SINGLE WALL / BACKSPLASH W/ SWIVEL ELBOW & 60" HOSE
ACCESSORIES	
2400-2103	CLOSE ELBOWS
10006	SUPPLY LINES 1/2" F X 1/2" M X 36" LONG (2 EACH. REQUIRES CLOSE ELBOWS)
2542	DUAL CHECK VACUUM BREAKER 1/4" FEMALE X 1/4" MALE



8" ADJ. WALLMOUNT UTILITY SPRAY HOSE UNIT

PART	DESCRIPTION
11770	8" ADJ. WALL W/ SWIVEL ELBOW , DUAL CHECK VACUUM BREAKER & 60" HOSE ADD ON FAUCET 14" SWING SPOUT
ACCESSORIES	
64238	BACKSPLASH MOUNTING NIPPLES (2 EACH)
71498	CLOSE ELBOWS (2 EACH. REQUIRES BACKSPLASH MOUNTING NIPPLES)
64351	SUPPLY LINES 1/2F X 1/2M X 36" LONG (2 EACH. REQUIRES CLOSE ELBOWS)



GLASS FILLER HOSE UNITS

PART	DESCRIPTION
1465	GLASS FILLER WITH 60" HOSE
ACCESSORIES	
6343	DECK FLANGE
2542	DUAL CHECK VACUUM BREAKER 1/4" FEMALE X 1/4" MALE



NIPPLES FOR ADJ. WALL UNITS

PART	DESCRIPTION
64238	NIPPLES FOR 1/2" ADJ. WALL UNITS 1/2" NPT MALE X 1/2" NPT MALE X 1 3/4" LONG W/ SLIP JOINT KIT (2 EACH)



ELBOWS FOR ADJ. WALL W/ NIPPLE & BACKSPASH UNITS

PART	DESCRIPTION
2400-2103	ELBOWS FOR 1/2" WALL W/ NIPPLES & BACKSPASH PRE-RINSE UNITS 1/2" NPT FEMALE X 1/2" NPT FEMALE
64211	ELBOWS FOR 1/2" WALL W/ NIPPLES & BACKSPASH PRE-RINSE UNITS 1/2" NPT FEMALE X 1/2" NPT FEMALE (2 EACH)



SUPPLY LINES FOR 1/2" UNITS

PART	DESCRIPTION
10006	SUPPLY LINES FOR 1/2" FEMALE X 1/2" MALE X 36" LONG
64351	SUPPLY LINES FOR 1/2" FEMALE X 1/2" MALE X 36" LONG (2 EACH)
10022	SUPPLY LINES FOR 1/2" FEMALE X 1/2" FEMALE X 36" LONG
75625	SUPPLY LINES FOR 1/2" FEMALE X 1/2" FEMALE X 36" LONG (2 EACH)

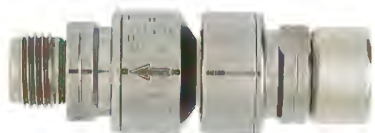

DUAL CHECK VALVES & VACUUM BREAKERS

PART	DESCRIPTION
2542	DUAL CHECK VACUUM BREAKER 3/4"-14 FEMALE X 3/4"-14 MALE



SPRAY VALVE BRUSH

PART	DESCRIPTION
2949-9001	SPRAY VALVE BRUSH



DECK FLANGE

PART	DESCRIPTION
6343	DECK FLANGE



8" BACKSPLASH CONTROL VALVE

PART	DESCRIPTION
13150	SWIVEL/RIGID OUTLET / CERAMIC STEMS



8" DECK CONTROL VALVE

PART	DESCRIPTION
33000	SWIVEL/RIGID OUTLET / CERAMIC STEMS



8" ADJ. WALL CONTROL VALVE

PART	DESCRIPTION
32000	SWIVEL/RIGID OUTLET / CERAMIC STEMS



8" ADJ. WALL WITH STOPS CONTROL VALVE

PART	DESCRIPTION
32010	SWIVEL/RIGID OUTLET / CERAMIC STEMS

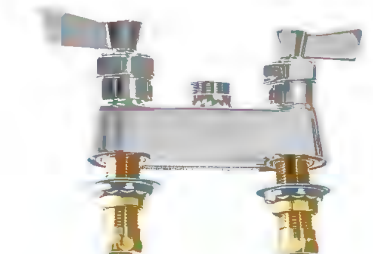

4" DECK CONTROL VALVE

PART	DESCRIPTION
35000	SWIVEL/RIGID OUTLET / CERAMIC STEMS

4" BACKSPLASH CONTROL VALVE



PART	DESCRIPTION
36000	SWIVEL/RIGID OUTLET / CERAMIC STEMS

DUAL DECK CONTROL VALVE



PART	DESCRIPTION
13060	SWIVEL/RIGID OUTLET / CERAMIC STEMS

SINGLE WALL / BACKSPLASH CONTROL VALVE



PART	DESCRIPTION
37000	SWIVEL/RIGID OUTLET / CERAMIC STEMS

SINGLE DECK CONTROL VALVE



PART	DESCRIPTION
12810	SWIVEL/RIGID OUTLET / CERAMIC STEMS



POT FILLER HOSE UNIT SUB-ASSEMBLIES WITH SWIVEL ELBOW VACUUM BREAKER

PART	DESCRIPTION
75568	POT FILLER HOSE UNIT SUB-ASSEMBLY WITH SWIVEL ELBOW VACUUM BREAKER & 60" HOSE
75570	POT FILLER HOSE UNIT SUB-ASSEMBLY WITH SWIVEL ELBOW VACUUM BREAKER & 96" HOSE

*INCLUDES SWIVEL ADAPTER FOR MOUNTING TO ADD-ON FAUCET IF USED



GLASS FILLER HOSE UNIT SUB-ASSEMBLIES WITH SWIVEL ELBOW VACUUM BREAKER

PART	DESCRIPTION
75571	GLASS FILLER HOSE UNIT SUB-ASSEMBLY WITH SWIVEL ELBOW VACUUM BREAKER & 60" HOSE
75572	GLASS FILLER HOSE UNIT SUB-ASSEMBLY WITH SWIVEL ELBOW VACUUM BREAKER & 96" HOSE

*INCLUDES SWIVEL ADAPTER FOR MOUNTING TO ADD-ON FAUCET IF USED



UTILITY SPRAY HOSE UNIT SUB-ASSEMBLIES WITH SWIVEL ELBOW VACUUM BREAKER

PART	DESCRIPTION
75577	UTILITY SPRAY HOSE UNIT SUB-ASSEMBLY WITH SWIVEL ELBOW VACUUM BREAKER & 60" HOSE
75579	UTILITY SPRAY HOSE UNIT SUB-ASSEMBLY WITH SWIVEL ELBOW VACUUM BREAKER & 96" HOSE

*INCLUDES SWIVEL ADAPTER FOR MOUNTING TO ADD-ON FAUCET IF USED



POT FILLER HOSE UNIT SUB-ASSEMBLIES WITH SWIVEL ELBOW

PART	DESCRIPTION
75573	POT FILLER HOSE UNIT SUB-ASSEMBLY WITH SWIVEL ELBOW & 60" HOSE
75574	POT FILLER HOSE UNIT SUB-ASSEMBLY WITH SWIVEL ELBOW & 96" HOSE

*INCLUDES SWIVEL ADAPTER FOR MOUNTING TO ADD-ON FAUCET IF USED



GLASS FILLER HOSE UNIT SUB-ASSEMBLIES WITH SWIVEL ELBOW

PART	DESCRIPTION
75575	GLASS FILLER HOSE UNIT SUB-ASSEMBLY WITH SWIVEL ELBOW & 60" HOSE
75576	GLASS FILLER HOSE UNIT SUB-ASSEMBLY WITH SWIVEL ELBOW & 96" HOSE

*INCLUDES SWIVEL ADAPTER FOR MOUNTING TO ADD-ON FAUCET IF USED



UTILITY SPRAY HOSE UNIT SUB-ASSEMBLIES WITH SWIVEL ELBOW VACUUM BREAKER

PART	DESCRIPTION
75580	UTILITY SPRAY HOSE UNIT SUB-ASSEMBLY WITH SWIVEL ELBOW & 60" HOSE
75581	UTILITY SPRAY HOSE UNIT SUB-ASSEMBLY WITH SWIVEL ELBOW & 96" HOSE

*INCLUDES SWIVEL ADAPTER FOR MOUNTING TO ADD-ON FAUCET IF USED



ADD-ON FAUCETS

PART	DESCRIPTION
29060	ADD-ON FAUCET W/ 4" RISER W/ 6" SPOUT
29120	ADD-ON FAUCET W/ 4" RISER W/ 12" SPOUT
29010	ADD-ON FAUCET W/ 4" RISER LESS SPOUT



1/2" SWING SPOUTS FOR ADD-ON FAUCET

PART	DESCRIPTION
3960	6" SWING SPOUT
3961	8" SWING SPOUT
3962	10" SWING SPOUT
3963	12" SWING SPOUT
3964	14" SWING SPOUT
3967	16" SWING SPOUT



ADAPTER KIT FOR UTILITY SPRAY OR POT FILLER

PART	DESCRIPTION
75964	ADAPTER KIT



BIBB CAP

PART	DESCRIPTION
75957	BIBB CAP



O-RING FOR 8" DECK FAUCET

PART	DESCRIPTION
75960	O-RING



INSTALL KIT FOR SINGLE DECK DUAL FAUCET

PART	DESCRIPTION
75962	INSTALL KIT

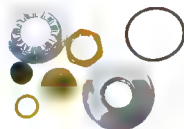

INSTALL KIT FOR 8" DECK

PART	DESCRIPTION
75961	INSTALL KIT



O-RING FOR SINGLE DECK FAUCET

PART	DESCRIPTION
75963	O-RING



NEOSTRAHL FULL FLOW STREAM AERATOR

PART	DESCRIPTION
75801	NEOSTRAHL FULL FLOW STREAMAERATOR 55/64-27



1/2" CERAMIC DISK STEM

CERAMIC	DESCRIPTION
75959	STEM 1/2" CERAMIC DISK RIGHT HAND REPLACEMENT
75958	STEM 1/2" CERAMIC DISK LEFT HAND REPLACEMENT

GLASS FILLER - CERAMIC

Fisher glass fillers feature great looks with a simplistic design and high quality construction for a long service life. They are ideal for restaurants, schools, healthcare facilities, grocery/retail facilities, hospitality facilities, and convenience stores. Fisher's ceramic products now come with a 4 year warranty.

Featuring a lifetime warranty on ceramic stems.

CHECK OUT THESE GLASS FILLER FEATURES:

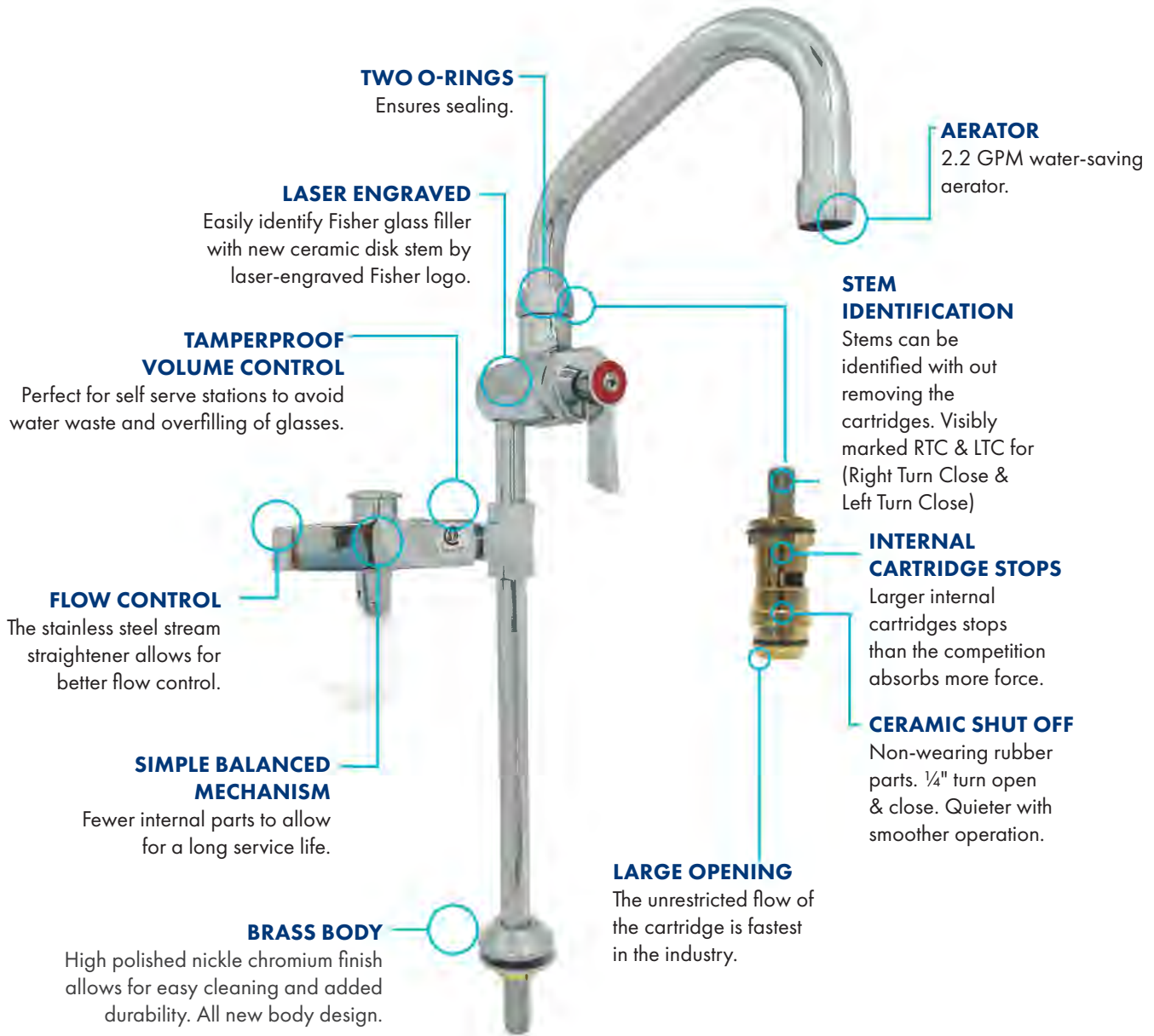

**ANSI/NSF 61,
SECTION 9 CERTIFIED**



GLASS /PITCHER FILLER

MODEL	DESCRIPTION
10090	GLASS/PITCHER FILLER 8" PEDESTAL 3/8" M

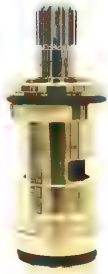

1/2" CERAMIC DISK STEM

CERAMIC	DESCRIPTION
75959	STEM 1/2" CERAMIC DISK RIGHT HAND REPLACEMENT

1/2" LAVATORY AND HAND SINK FAUCETS - BRASS

1/2" LAVATORY AND HAND SINK FAUCETS - BRASS

Fisher is knowledgeable about healthcare. For more than 87 years, we have provided top-notch faucets and plumbing supplies to clinics, hospitals, nursing homes, physician offices, and other healthcare facilities. Our breadth of products wins the confidence of plumbing engineers and medical facilities worldwide, demonstrating our lengthy experience. We incorporate a thorough understanding of the demands of the industry into each design, providing precise solutions made especially for healthcare settings. Fisher now has a 4-year warranty on brass.



INTERNATIONALLY COLOR CODED IDENTIFICATION BUTTONS ON HANDLES
Hot (red) and cold (blue) for safety.

AERATOR
0.35 GPM water saving aerator.

BRASS BODY
High polished nickel chromium finish allows for easy cleaning and added durability.



4" DECK LAVATORY FAUCETS

BRASS	DESCRIPTION
1744	4" DECK W/ LAVATORY SPOUT
ACCESSORIES	
75625	SUPPLY LINES 1/2" F X 1/2" F X 36" LONG (2 EACH)



SINGLE DECK LAVATORY FAUCETS

BRASS	DESCRIPTION
1731	SINGLE DECK W/ LAVATORY SPOUT
ACCESSORIES	
10022	SUPPLY LINES 1/2" F X 1/2" F X 36" LONG



BACKSPLASH BAR & HAND SINK BASES

BRASS	DESCRIPTION
2038	BACKSPLASH BASE W/ 6" SWIVEL GOOSENECK SPOUT
3915	BACKSPLASH BASE W/ 12" SWIVEL GOOSENECK SPOUT
9131	BACKSPLASH BASE W/ 6" RIGID GOOSENECK SPOUT
3916	BACKSPLASH BASE W/ 12" RIGID GOOSENECK SPOUT
ACCESSORIES	
2400-2103	CLOSE ELBOWS 1/2"
10006	SUPPLY LINES 1/2" F X 1/2" M X 36" LONG (REQUIRES CLOSE ELBOW)

*INCLUDES NIPPLE FOR BACKSPLASH MOUNTING



DECK BASE BAR & HAND SINK BASES

BRASS	DESCRIPTION
1929	DECK BASE W/ 6" SWIVEL / GOOSENECK SPOUT
3815	DECK BASE W/ 12" SWIVEL / GOOSENECK SPOUT
1937	DECK BASE W/ 6" RIGID GOOSENECK SPOUT
3816	DECK BASE W/ 12" RIGID GOOSENECK SPOUT
ACCESSORIES	
10022	SUPPLY LINES 1/2" F X 1/2" F X 36" LONG

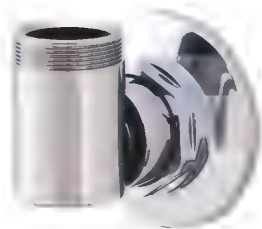

SINGLE BACKSPASH BASE

BRASS LEVER HANDLES	DESCRIPTION
3900	SWIVEL OUTLET
3900-0002	3/8" FEMALE OUTLET



SINGLE DECK BASE

BRASS LEVER HANDLES	DESCRIPTION
3800	SWIVEL OUTLET
2903	3/8" FEMALE OUTLET



1/2" SWIVEL GOOSENECK SPOUTS

BRASS	DESCRIPTION
3968	6" SWIVEL GOOSENECK SPOUT
3965	12" SWIVEL GOOSENECK SPOUT

*SPOUT REQUIRE CONTROL VALVES WITH SWIVEL OUTLET AND SWIVEL STEMS



1/2" RIGID GOOSENECK SPOUTS

BRASS	DESCRIPTION
3969	6" RIGID GOOSENECK SPOUT
3966	12" RIGID GOOSENECK SPOUT



ELBOWS FOR WALL FAUCETS

BRASS	DESCRIPTION
2400-2103	CLOSE ELBOW FOR BACKSPASH CONTROL VALVE OR WALL CONTROL VALVE WITH BACKSPASH MOUNTING NIPPLE 1/2"
64211	CLOSE ELBOWS FOR BACKSPASH CONTROL VALVES OR WALL CONTROL VALVES WITH BACKSPASH MOUNTING NIPPLES 1/2" (2 EACH)



SUPPLY LINES

BRASS	DESCRIPTION
10006	SUPPLY LINE 1/2" FEMALE X 1/2" FEMALE X 36" LONG FOR DECK MOUNT CONTROL VALVES AND BASES (2 EACH)
64351	SUPPLY LINE 1/2" FEMALE X 1/2" MALE X 36" LONG FOR BACKSPASH MOUNTED CONTROL VALVES WITH ELBOWS (2 EACH)
10022	SUPPLY LINE 1/2" FEMALE X 1/2" FEMALE X 36" LONG FOR DECK MOUNT CONTROL VALVE AND BASE
75625	SUPPLY LINE 1/2" FEMALE X 1/2" FEMALE X 36" LONG FOR DECK MOUNT CONTROL VALVES AND BASES (2 EACH)

THIS PAGE INTENTIONALLY BLANK

NAVIGATOR™ ELECTRONIC SENSOR FAUCETS - BRASS

Hospitals, schools, and food service operations are always looking to conserve water, promote better health practices and cut costs when possible. Now, Fisher offers an innovative way to do it all with our Navigator™ Sensor Faucets. These innovative systems give the ability to turn on and turn off water completely hands free with sensor technology. Available in both wall mount and deck mount setups our Navigator™ Sensor Faucets bring convenience, efficiency and reliability to your operation. Fisher now has a 3 year warranty on Sensor Faucets.

CHECK OUT THE FEATURES OF OUR SENSOR FAUCET:

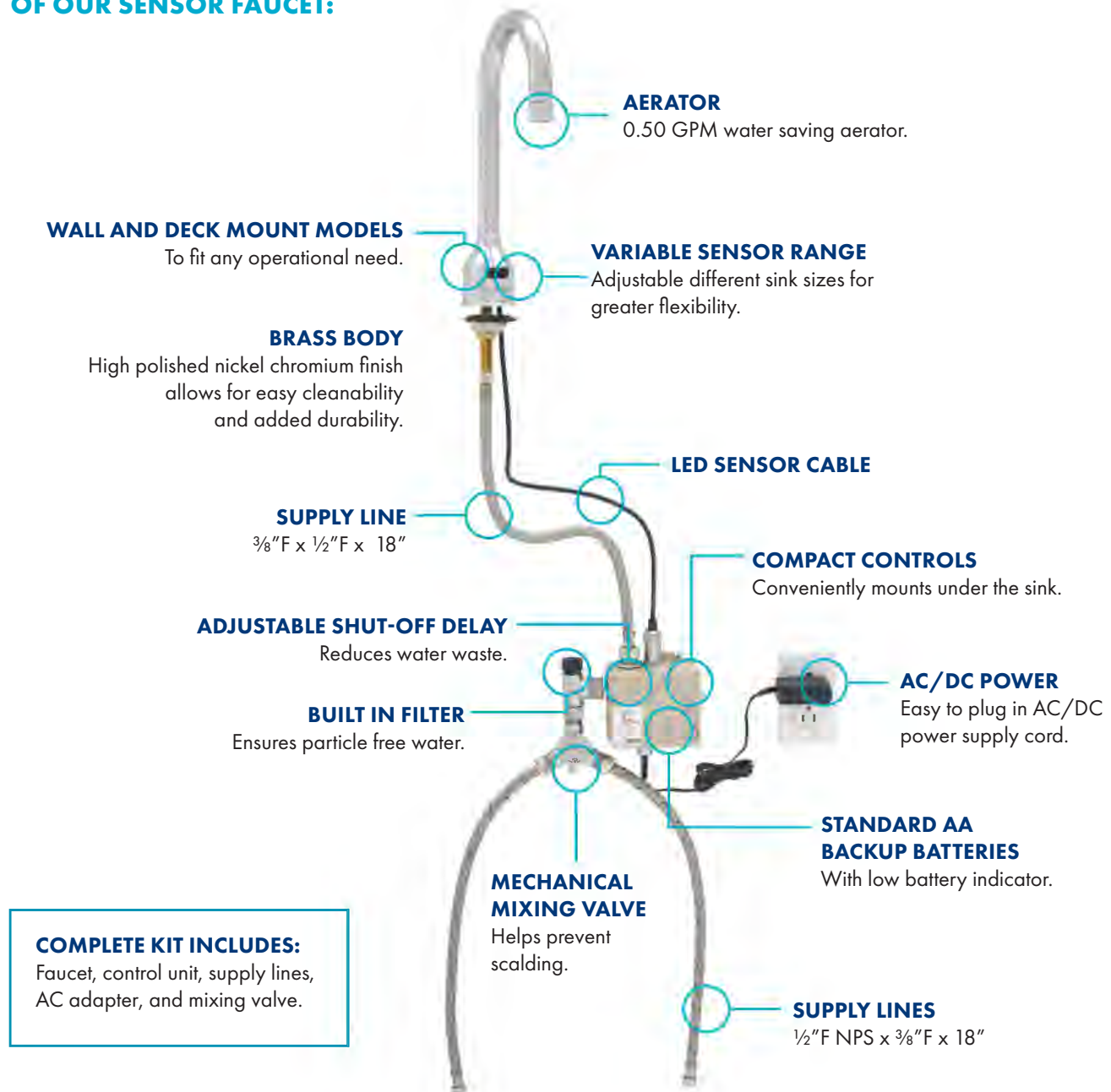



SINGLE BACKSPLASH SENSOR FAUCETS

MODEL	DESCRIPTION
73750	SINGLE BACKSPLASH W/ ELBOWS & 12" RIGID GOOSENECK SPOUT 0.50 GPM



SINGLE DECK SENSOR FAUCETS

MODEL	DESCRIPTION
73751	SINGLE DECK W/ 12" RIGID GOOSENECK SPOUT 0.50 GPM

3/4" FAUCETS - BRASS

Fisher has designed a line of 3/4" Pot Sink Faucets to save time on filling large pot sinks. Fisher's 3/4" Faucets are totally dedicated to providing large volumes of water in a short period of time. They are ideal for filling big vessels quickly by going from zero to 100 gallons of water in 180 seconds! Also, Fisher brass products now come with a 4 year warranty.

CHECK OUT THE FEATURES OF OUR 3/4" FAUCET:

STANDARD SWIVELING SEAT DISKS

Pivot on the stems so that there isn't any twisting against the seats to allow for longer seat washer life.

TWO O-RINGS

Ensures a proper seal.

1" DIAMETER SPOUT WITHOUT AERATOR

Ensures full flow.

INTERNATIONALLY COLOR CODED IDENTIFICATION BUTTONS ON HANDLES

Hot (red) and cold (blue) for safety.

BRASS BODY

High polished nickel chromium finish allows for easy cleaning and added durability.

STAINLESS STEEL SEAT

Resists abrasion and comes with a **lifetime guarantee** against leaks.





3/4" 8" BACKSPASH SINK FAUCETS

BRASS	DESCRIPTION
5412	8" BACKSPASH W/10" SWING SPOUT AND ELBOWS
5414	8"BACKSPASH W/14" SWING SPOUT AND ELBOWS

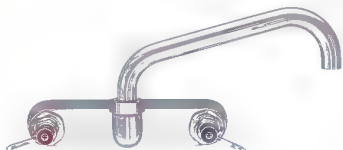

3/4" 8" ADJ WALLMOUNT SINK FAUCET

BRASS	DESCRIPTION
5212	8" ADJ WALLMOUNT W/10" SWING SPOUT
5214	8" ADJ WALLMOUNT W/14" SWING SPOUT



3/4" 8" DECK MOUNT SINK FAUCET

BRASS	DESCRIPTION
5312	8" DECK MOUNT W/ 10" SWING SPOUT
5314	8" DECK MOUNT W/10" SWING SPOUT



3/4" SINGLE WALL SINK FAUCET

BRASS	DESCRIPTION
5712	SINGLE WALL W/ 10" SWING SPOUT
5714	SINGLE WALL W/10" SWING SPOUT



3/4" SINGLE DECK MOUNT SINK FAUCET

BRASS	DESCRIPTION
5012	SINGLE DECK MOUNT W/10" SWING SPOUT
5014	SINGLE DECK MOUNT W/14" SWING SPOUT



3/4" 8" BACKSPASH CONTROL VALVES

BRASS	DESCRIPTION
5400	SWIVEL OUTLET / SWIVEL STEMS
5400-CV	SWIVEL OUTLET / CHECK STEMS



3/4" 8" ADJ. WALL CONTROL VALVES

BRASS	DESCRIPTION
5200	SWIVEL OUTLET / SWIVEL STEMS
5200-CV	SWIVEL OUTLET / CHECK STEMS
ACCESSORIES	
10219	BACKSPASH MOUNTING NIPPLE
5000-2103	CLOSE ELBOW (REQUIRES BACKSPASH MOUNTING NIPPLES)



3/4" 8" DECK CONTROL VALVES

BRASS	DESCRIPTION
BRASS	ULTRA SPRAY VALVE PLUS 1.15 GPM KNIFE EDGE SPRAY PATTERN
5300	ULTRA SPRAY VALVE 7 PLUS .70 GPM KNIFE EDGE SPRAY PATTERN



3/4" SINGLE WALL / BACKSPASH CONTROL VALVES

BRASS	DESCRIPTION
5700	SWIVEL OUTLET / SWIVEL STEMS
ACCESSORIES	
5000-2103	CLOSE ELBOW

*INCLUDES NIPPLE FOR BACKSPASH MOUNTING

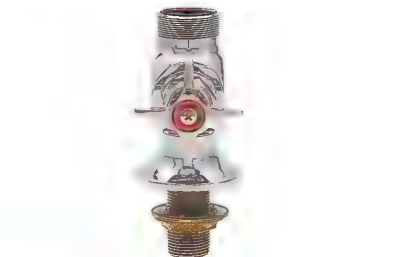

3/4" SINGLE DECK CONTROL VALVES

BRASS	DESCRIPTION
5000	SWIVEL OUTLET / SWIVEL STEMS



3/4" SWING SPOUTS

BRASS	DESCRIPTION
5000-0001	3/4" 10" SWING SPOUT
5000-0002	3/4" 14" SWING SPOUT



3/4" DJ

BRASS	DESCRIPTION
5000-0003	3/4" 10" DOUBLE JOINTED SPOUT



3/4" CONTROL SPOUT

BRASS	DESCRIPTION
5071	3/4" 10" CONTROL SPOUT



3/4" ADDON FAUCET LESS SPOUT

BRASS	DESCRIPTION
21482	3/4" ADDON FAUCET LESS SPOUT

3/4" POT FILLERS - BRASS

Never carry a heavy pot filler of water to the range again. Instead, fill the pot up with a 3/4" Fisher pot filler faucet mounted right by your range for easy access to water. Designed for high volume use and engineered for maximum durability. Our 3/4" pot filler faucets are ideal for restaurants, healthcare facilities, schools, military institutions, hotel banquet operations, and more. Fisher now offers a 4 year warranty on brass.

CHECK OUT THESE 3/4" POT FILLER FAUCET FEATURES:

CONTROL SWING SPOUT & DOUBLE JOINTED SUB-ASSEMBLY

Designed for high volume use and cover large areas to deliver water exactly where you need it.

AERATOR

29 GPM flow rate helps deliver water exactly where you need it with extra flow in any application.

ON-OFF BLACK KNOB

The heat resistant and easy to grip knob provides added safety over cooking areas while also allowing for a quick turn on or off of the water.

TWO O-RINGS

Ensures a proper seal.

INTERNATIONALLY COLOR CODED IDENTIFICATION BUTTONS ON HANDLES

Hot (red) and cold (blue) for safety.

TWO PART CHECK STEMS

For the prevention of backflow and lower maintenance.

STAINLESS STEEL SEATS

Resists abrasion and comes with a **lifetime guarantee** against leaks.

BRASS BODY

The high polished nickel chromium finish allows for easy cleaning and added durability.

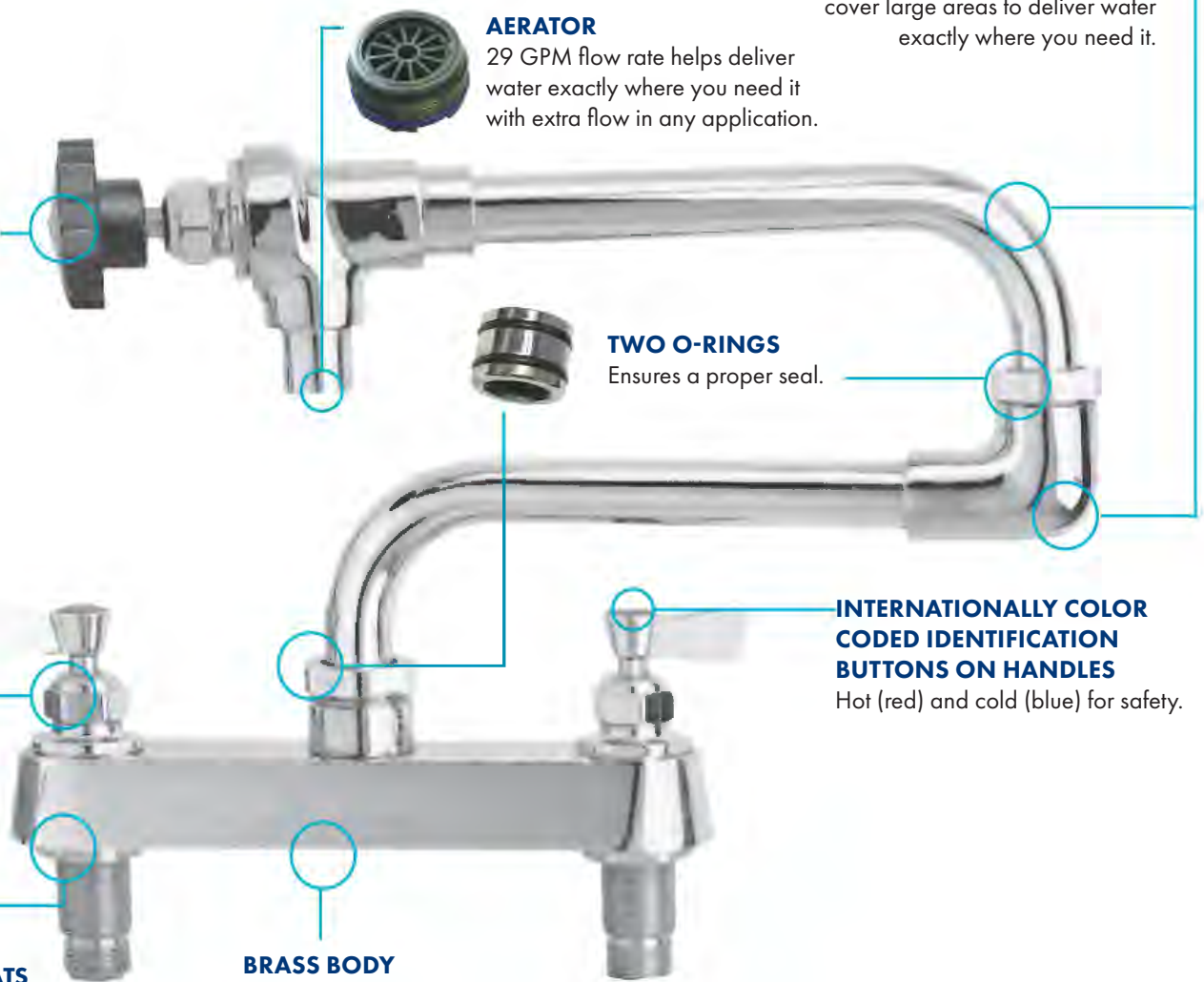



3/4" SINGLE WALL POT FILLER FAUCET WITH 10" DOUBLE JOINT & 10" CONTROL SPOUT

BRASS	DESCRIPTION
5730	3/4" SINGLE WALL FAUCET WITH 10" DOUBLE JOINT & 10" CONTROL SPOUT



3/4" 8" BACKSPLASH POT FILLER FAUCET WITH ELBOWS AND 10" DOUBLE JOINT & 10" CONTROL SPOUT

BRASS	DESCRIPTION
2283	3/4" 8" BACKSPLASH POT FILLER FAUCET WITH ELBOWS AND 10" DOUBLE JOINT & 10" CONTROL SPOUT



3/4" 8" ADJUSTABLE WALLMOUNT POT FILLER FAUCET WITH 10" DOUBLE JOINT & 10" CONTROL SPOUT

BRASS	DESCRIPTION
2267	3/4" 8" ADJUSTABLE WALLMOUNT POT FILLER FAUCET WITH 10" DOUBLE JOINT & 10" CONTROL SPOUT



3/4" 8" DECK MOUNT POT FILLER FAUCET WITH 10" DOUBLE JOINT & 10" CONTROL SPOUT

BRASS	DESCRIPTION
2275	3/4" 8" DECK MOUNT POT FILLER FAUCET WITH 10" DOUBLE JOINT & 10" CONTROL SPOUT

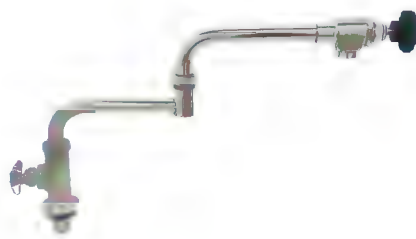

3/4" SINGLE DECK POT FILLER FAUCET WITH 10" DOUBLE JOINT SPOUT & 10" CONTROL SWING SPOUT

BRASS	DESCRIPTION
5030	3/4" SINGLE DECK POT FILLER FAUCET WITH 10" DOUBLE JOINT SPOUT & 10" CONTROL SWING SPOUT



3/4" SINGLE DECK CONTROL VALVE

BRASS	DESCRIPTION
5000	SWIVEL OUTLET/CHECK STEMS

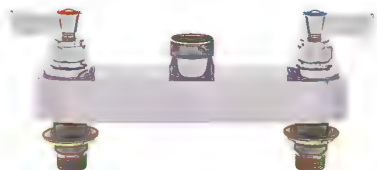

3/4" 8" DECK CONTROL VALVE

BRASS	DESCRIPTION
5300-CV	SWIVEL OUTLET/CHECK STEMS



3/4" SINGLE WALL/BACKSPLASH CONTROL VALVE

BRASS	DESCRIPTION
5700	SWIVEL OUTLET /CHECK STEMS



3/4" 8" BACKSPLASH CONTROL VALVE

BRASS	DESCRIPTION
5400-CV	SWIVEL OUTLET/CHECK STEMS



3/4" 8" ADJUSTABLE WALLMOUNT CONTROL VALVE

BRASS	DESCRIPTION
5200-CV	3/4" 8" ADJUSTABLE WALLMOUNT CONTROL VALVE



3/4" 10" CONTROL SWING SPOUT

BRASS	DESCRIPTION
5071	10" CONTROL SWING SPOUT



3/4" 10" DOUBLE JOINTED SPOUT

BRASS	DESCRIPTION
5000-0003	10" DOUBLE JOINTED SPOUT

3/4" POT KETTLE FILLER FAUCETS - BRASS

Fisher's 3/4" Pot Kettle Filler faucets are the perfect way to quickly fill up kettles and pots in a bustling kitchen. When high volume filling jobs are a regular necessity, you can rely on the heavy-duty Pot Kettle fillers by Fisher. Our 3/4" Pot Kettle Filler Faucet fulfill the demanding needs of high-volume kitchens in restaurants, healthcare facilities, schools, military facilities, hotel banquet operations, and more. Fisher now has a 4-year warranty on brass.

CHECK OUT THE FEATURES OF OUR 3/4" KETTLE FILLER:

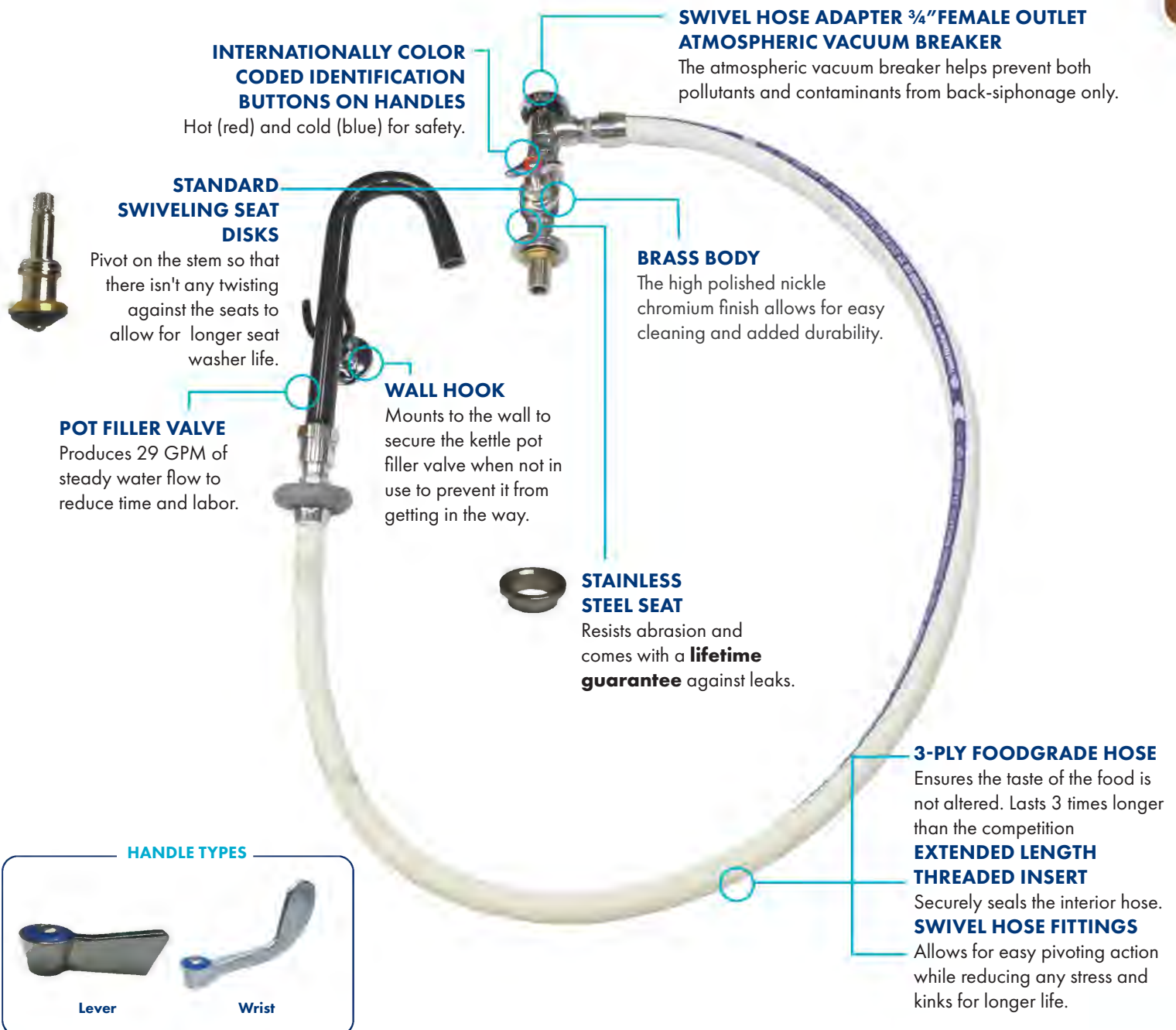

INTERNATIONALLY COLOR CODED IDENTIFICATION BUTTONS ON HANDLES

Hot (red) and cold (blue) for safety.

SWIVEL HOSE ADAPTER 3/4" FEMALE OUTLET ATMOSPHERIC VACUUM BREAKER

The atmospheric vacuum breaker helps prevent both pollutants and contaminants from back-siphonage only.

STANDARD SWIVELING SEAT DISKS

Pivot on the stem so that there isn't any twisting against the seats to allow for longer seat washer life.

BRASS BODY

The high polished nickel chromium finish allows for easy cleaning and added durability.

POT FILLER VALVE

Produces 29 GPM of steady water flow to reduce time and labor.

WALL HOOK

Mounts to the wall to secure the kettle pot filler valve when not in use to prevent it from getting in the way.

STAINLESS STEEL SEAT

Resists abrasion and comes with a **lifetime guarantee** against leaks.

3-PLY FOODGRADE HOSE

Ensures the taste of the food is not altered. Lasts 3 times longer than the competition

EXTENDED LENGTH THREADED INSERT

Securely seals the interior hose.

SWIVEL HOSE FITTINGS

Allows for easy pivoting action while reducing any stress and kinks for longer life.

HANDLE TYPES

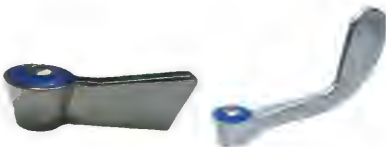

Lever

Wrist



3/4" 8" BACKSPLASH POT FILLER HOSE UNIT

BRASS	DESCRIPTION
5440	3/4" 8" BACKSPLASH POT FILLER WITH ELBOWS AND SWIVEL VACUUM BREAKER & 72" HOSE



3/4" 8" ADJUSTABLE WALL POT FILLER HOSE UNIT

BRASS	DESCRIPTION
5240	3/4" 8" ADJUSTABLE WALLMOUNT POT FILLER WITH SWIVEL VACUUM BREAKER & 72" HOSE



3/4" 8" DECK POT FILLER HOSE UNIT

BRASS	DESCRIPTION
5340	3/4" 8" DECK MOUNT POT FILLER WITH SWIVEL VACUUM BREAKER & 72" HOSE



3/4" SINGLE WALL/BACKSPLASH POT FILLER HOSE UNIT

BRASS	DESCRIPTION
5740	3/4" SINGLE WALL POT FILLER WITH SWIVEL VACUUM BREAKER & 72" HOSE



3/4" SINGLE DECK POT FILLER HOSE UNIT

BRASS	DESCRIPTION
5040	3/4" SINGLE DECK POT FILLER FAUCET WITH 10" DOUBLE JOINT SPOUT & 10" CONTROL SWING SPOUT



3/4" 8" BACKSPLASH CONTROL VALVES

BRASS	DESCRIPTION
5400	SWIVEL OUTLET/SWIVEL STEMS



3/4" 8" ADJUSTABLE WALL CONTROL VALVES

BRASS	DESCRIPTION
5200	SWIVEL OUTLET/SWIVEL STEMS



3/4" 8" DECK CONTROL VALVES

BRASS	DESCRIPTION
5300	SWIVEL OUTLET/SWIVEL STEMS



3/4" SINGLE WALL/BACKSPLASH CONTROL VALVES

BRASS	DESCRIPTION
5700	SWIVEL OUTLET/SWIVEL STEM



3/4" SINGLE DECK CONTROL VALVES

BRASS	DESCRIPTION
5000	SWIVEL OUTLET/SWIVEL STEM



3/4" SWIVEL VACUUM BREAKER

BRASS	DESCRIPTION
10480	ADAPTER SWIVEL 3/4" VACUUM BREAKER



WALL HOOK

BRASS	DESCRIPTION
2907	WALL HOOK



3/4" NIPPLE WITH LOCKNUT AND WASHER

BRASS	DESCRIPTION
10219	3/4" NIPPLE W/LOCKNUT AND WASHER



3/4" CLOSE ELBOW FEMALE

BRASS	DESCRIPTION
5000-2103	3/4" CLOSE ELBOW FEMALE

DISH MACHINE & SCRAP FITTINGS

Fisher Dish Machine products are designed in brass and stainless steel and made for long service life. The atmospheric vacuum breaker is designed to protect against contaminated water from being siphoned back into the clean water supply. The Trough Water and Inlet fittings keep your faucet working properly. They are designed specifically to reduce the risk of food contamination by washing away waste in scrap station, making them ideal for kitchen prep areas. Ideal for kitchen prep areas. Fisher now has a 4-year warranty on Brass and 10-year warranty in Stainless Steel.

CHECK OUT THESE DISH MACHINE & SCRAP FITTINGS FEATURES:

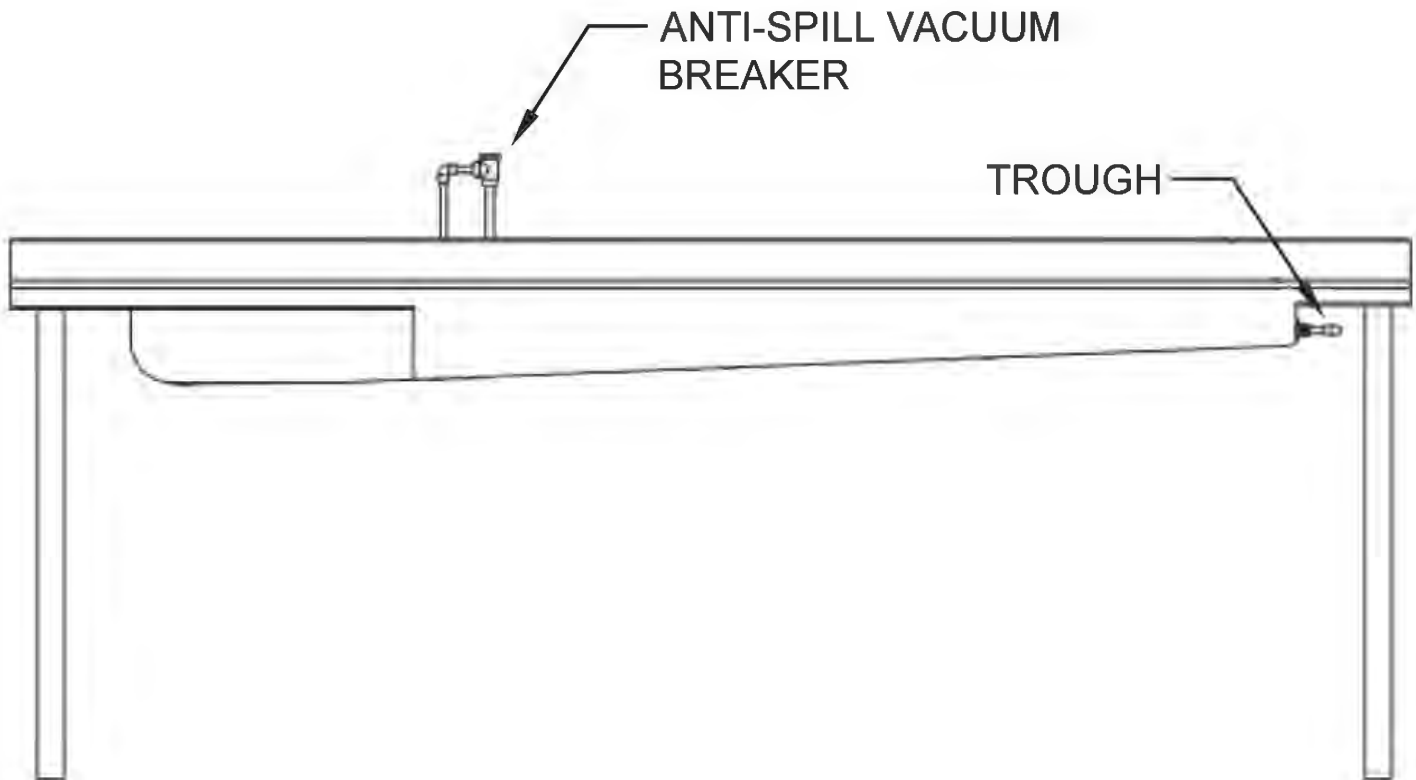



INLET FITTING

STAINLESS	DESCRIPTION
2905	TROUGH WATER INLET FITTING



INLET FITTING

BRASS	DESCRIPTION
81930	INLET FITTING ASSEMBLY 3 GASKETS



VACUUM BREAKER

BRASS	DESCRIPTION
3990	LEDGE MOUNT ATMOSPHERIC VACUUM BREAKER 1/2" X 6"



STRAIGHT STOP

BRASS CROSS HANDLE	DESCRIPTION
2933	STRAIGHT STOP 1/2" FEMALE INLET X 1/2" FEMALE OUTLET



TEMPERATURE ADJUSTING VALVE

BRASS	DESCRIPTION
2970-3	TEMPERATURE ADJUSTING VALVE 1/2" MALE INLETS X 1/2" FEMALE SLIP JOINT OUTLET W/ CHECK VALVES

DIPPERWELL FAUCET - BRASS

Fisher's dipperwell faucet is the perfect solution for keeping ice cream scoops clean and ready to use at your restaurant, concession stand, or ice cream shop. One of the key features of the dipperwell faucet is that it keeps ice cream scoops and paddles sanitized with a continuously running fresh stream of water through the dipperwell sink to aid in the prevention of potential flavor transfers or cross contamination between uses. Fisher now has a 4 year warranty on brass.

CHECK OUT THESE DIPPERWELL FAUCET FEATURES:

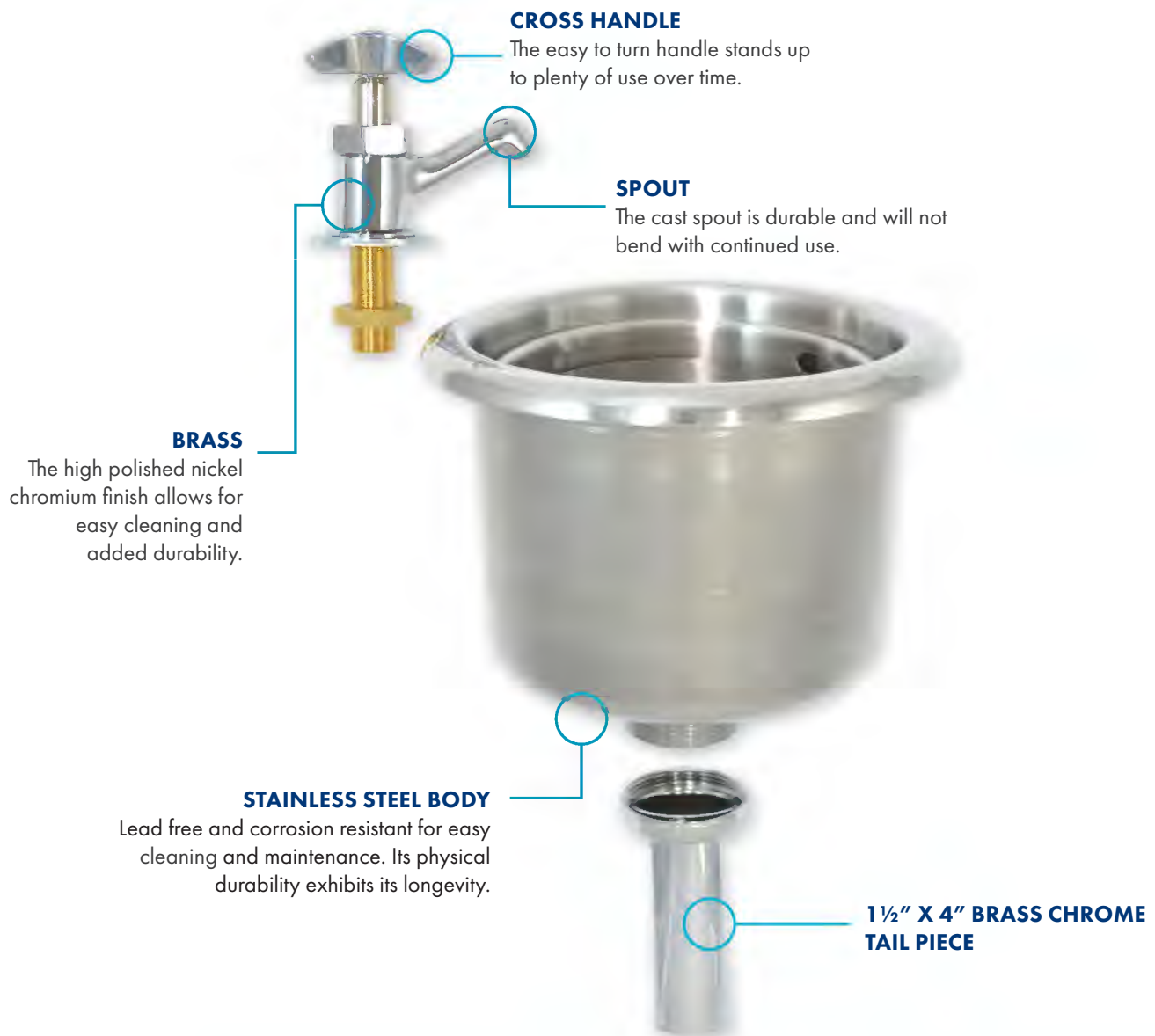



DIPPERWELL FAUCET

BRASS	DESCRIPTION
3041	DIPPERWELL FAUCET W/ SINK & TAILPIECE
3042	DIPPERWELL FAUCET ONLY

FOOT AND KNEE VALVES - BRASS

Fisher foot/knee valves are a perfect solution for going hands free. They have self-closing, foot operated valves that eliminate the possibility of contamination from germ-laden or dirty dishes. They are easy to operate and are available in single or double valves for easy floor, wall, or knee heights installations. Ideal for restaurants, hospitals, schools, hotels, restrooms, and more. Fisher now has a 4 year warranty on brass.

CHECK OUT THESE FOOT/KNEE VALVE FEATURES:

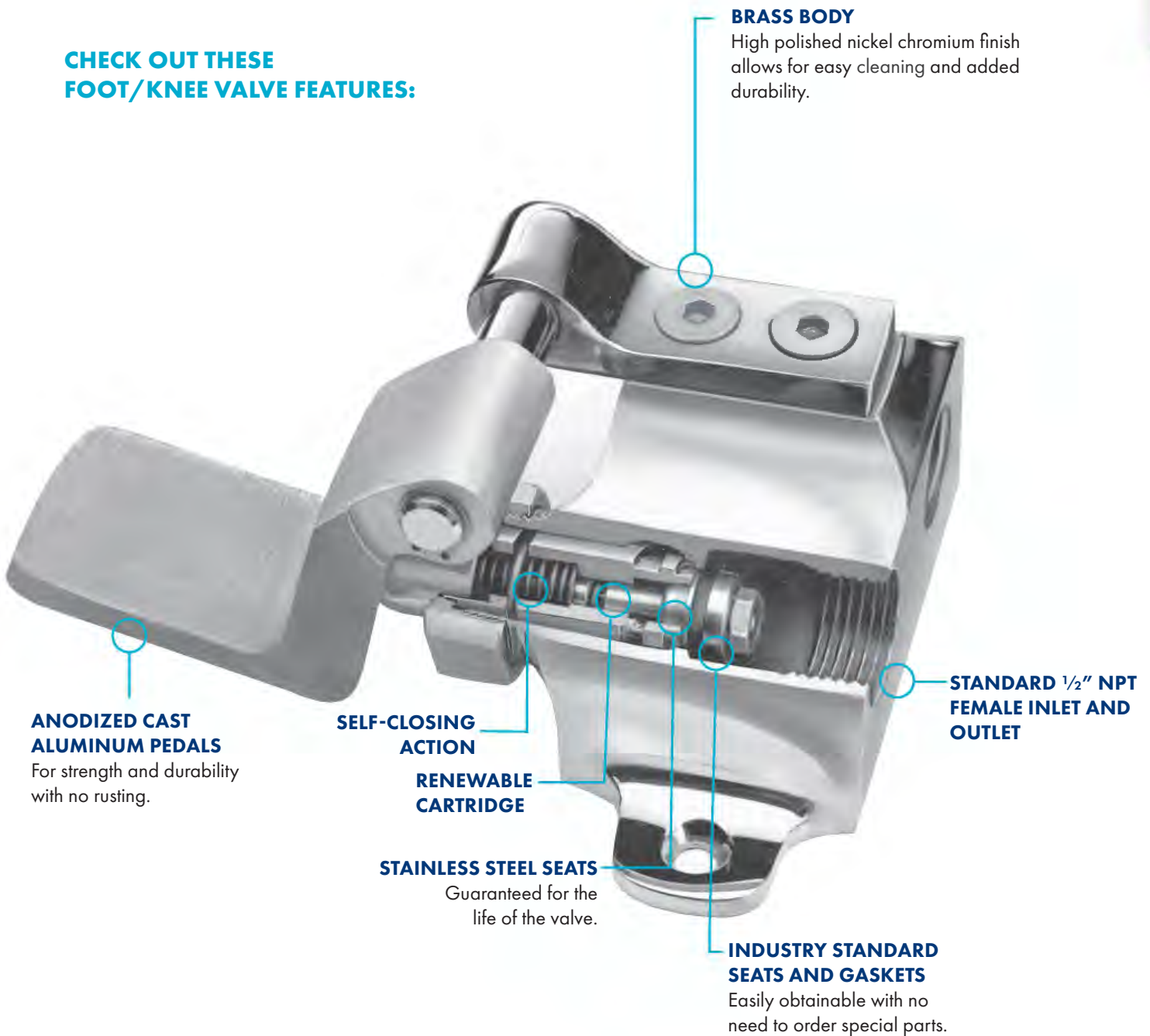



SINGLE PEDAL UNDER SINK MOUNT KNEE VALVE

BRASS	DESCRIPTION
3074	SINGLE PEDAL UNDER SINK MOUNT KNEE VALVE
ACCESSORIES	
2970-3	TEMPERATURE CONTROL VALVE INLETS ½M X OUTLET ½F



SINGLE PEDAL FLOOR MOUNT FOOT VALVE

BRASS	DESCRIPTION
3070	SINGLE PEDAL FLOOR MOUNT FOOT VALVE
ACCESSORIES	
2970-3	TEMPERATURE CONTROL VALVE INLETS ½M X OUTLET ½F



SINGLE PEDAL WALL MOUNT FOOT VALVE

BRASS	DESCRIPTION
3076	SINGLE PEDAL VALVE WALL MOUNT FOOT VALVE
ACCESSORIES	
2970-3	TEMPERATURE CONTROL VALVE INLETS ½M X OUTLET ½F



DUAL PEDAL UNDER SINK MOUNT KNEE VALVE

BRASS	DESCRIPTION
3174	DUAL PEDAL UNDER SINK MOUNT KNEE VALVE

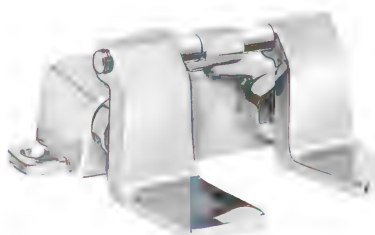

DUAL PEDAL FLOOR MOUNT FOOT VALVE

BRASS	DESCRIPTION
3170	DUAL Pedal Floor Mount Foot Valve



DUAL PEDAL WALL MOUNT FOOT VALVE

BRASS	DESCRIPTION
3176	DUAL PEDAL WALL MOUNT FOOT VALVE



BACKSPLASH BAR & HAND SINK BASES

BRASS	DESCRIPTION
2038	BACKSPLASH BASE W/ 6" SWIVEL GOOSENECK SPOUT
3915	BACKSPLASH BASE W/ 12" SWIVEL GOOSENECK SPOUT
9131	BACKSPLASH W/6" RIGID GOOSENECK SPOUT
3916	BACKSPLASH W/12" RIGID GOOSENECK SPOUT
ACCESSORIES	
2400-2103	CLOSE ELBOW 1/2"
10006	SUPPLY LINES 1/2" F X 1/2" M X 36" LONG (REQUIRES CLOSE ELBOWS)

DECK BAR & HAND SINK BASES

BRASS	DESCRIPTION
1929	DECK BASE W/6" SWIVEL GOOSENECK SPOUT
3815	DECK BASE W/12" SWIVE GOOSENECK SPOUT
1937	DECK BASE W/6" RIGID GOOSENECK SPOUT
3816	DECK BASE W/12" RIGID GOOSENECK SPOUT
ACCESSORIES	
10222	SUPPLY LINE 1/2" F X 1/2" F X 36" LONG

GLASS FILLER - BRASS

Fisher glass fillers feature great looks with a simplistic design and high quality construction for a long service life. They are available in your choice of models to meet virtually any water service installation and need. They are ideal for restaurants, schools, healthcare facilities, grocery/retail facilities, hospitality facilities, and convenience stores. Fisher now has a 4 year warranty on brass.

CHECK OUT THESE GLASS FILLER FEATURES:

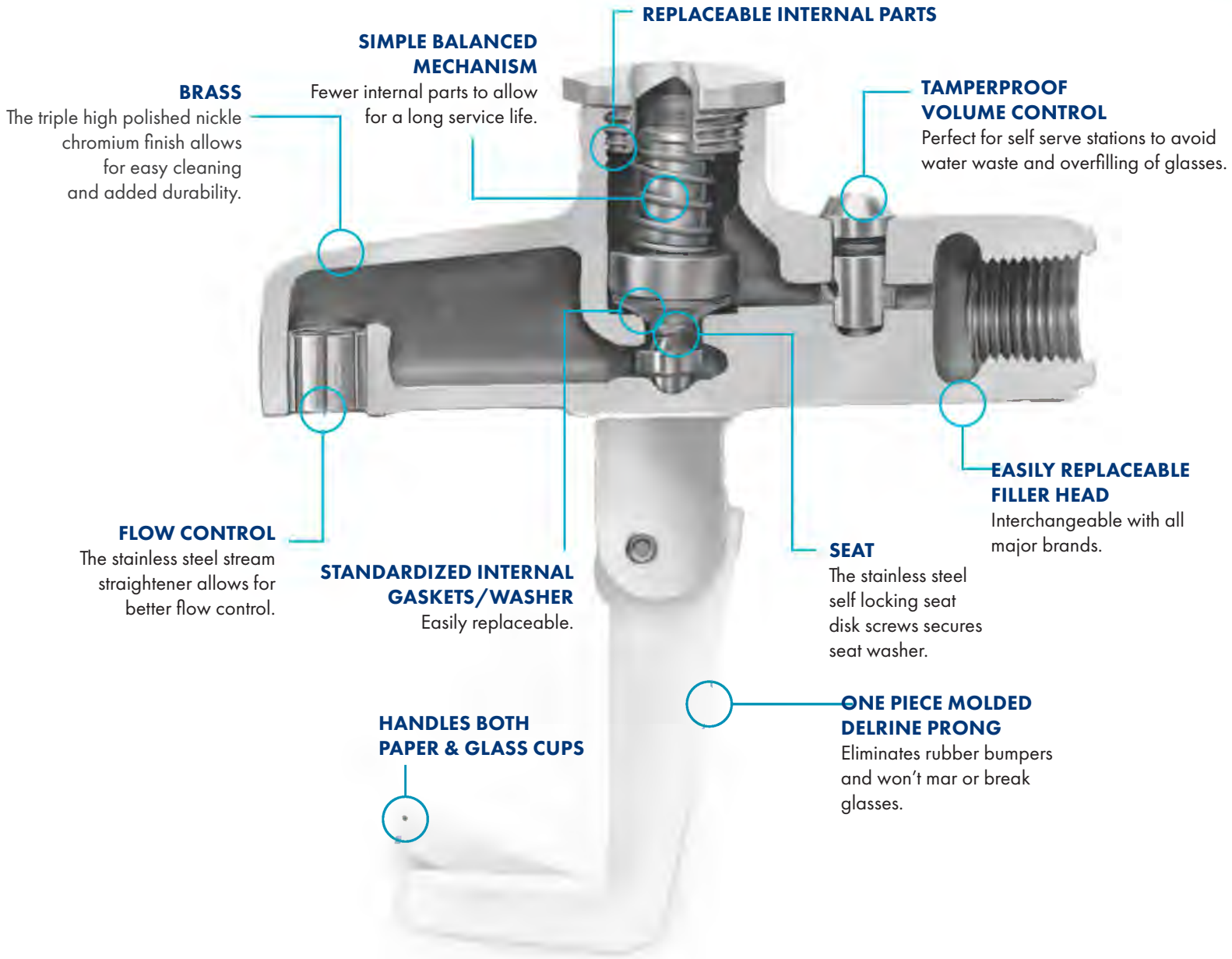

BRASS

The triple high polished nickel chromium finish allows for easy cleaning and added durability.

SIMPLE BALANCED MECHANISM

Fewer internal parts to allow for a long service life.

REPLACEABLE INTERNAL PARTS

TAMPERPROOF VOLUME CONTROL

Perfect for self serve stations to avoid water waste and overfilling of glasses.

FLOW CONTROL

The stainless steel stream straightener allows for better flow control.

STANDARDIZED INTERNAL GASKETS/WASHER

Easily replaceable.

SEAT

The stainless steel self locking seat disk screws secures seat washer.

EASILY REPLACEABLE FILLER HEAD

Interchangeable with all major brands.

ONE PIECE MOLDED DELRINE PRONG

Eliminates rubber bumpers and won't mar or break glasses.

HANDLES BOTH PAPER & GLASS CUPS

**ANSI/NSF 61,
SECTION 9 CERTIFIED**



PEDESTAL GLASS FILLER

BRASS	DESCRIPTION
1007	8" PEDESTAL GLASS FILLER
1008	10" PEDESTAL GLASS FILLER
12513	12" PEDESTAL GLASS FILLER
12726	14" PEDESTAL GLASS FILLER



PEDESTAL GLASS FILLER W/ SINK

BRASS	DESCRIPTION
1400	10" PEDESTAL GLASS FILLER W/ SINK
89494	12" PEDESTAL GLASS FILLER W/ SINK
83895	14" PEDESTAL GLASS FILLER W/ SINK



ICE MACHINE GLASS FILLER

BRASS	DESCRIPTION
10200	GLASS FILLER HEAD 3/8" F



ICE MACHINE GLASS FILLER

BRASS	DESCRIPTION
9033	GLASS FILLER 1/4" FEMALE X 1/2" MALE W/ 1/4" TUBE FITTING



SPRING STYLE GLASS RACK GLASS FILLER

BRASS LEVER HANDLE	DESCRIPTION
11170	SINGLE DECK CERAMIC

1/2" KITCHEN FAUCETS - STAINLESS STEEL

Industry leading quality, reliability, and savings in cost of ownership, have helped make Fisher faucets an industry standard. They exceed customer expectations in multiple markets from restaurants and bars, to educational, healthcare, grocery/retail, and hospitality facilities. Fisher now has a 10 year warranty on stainless steel.

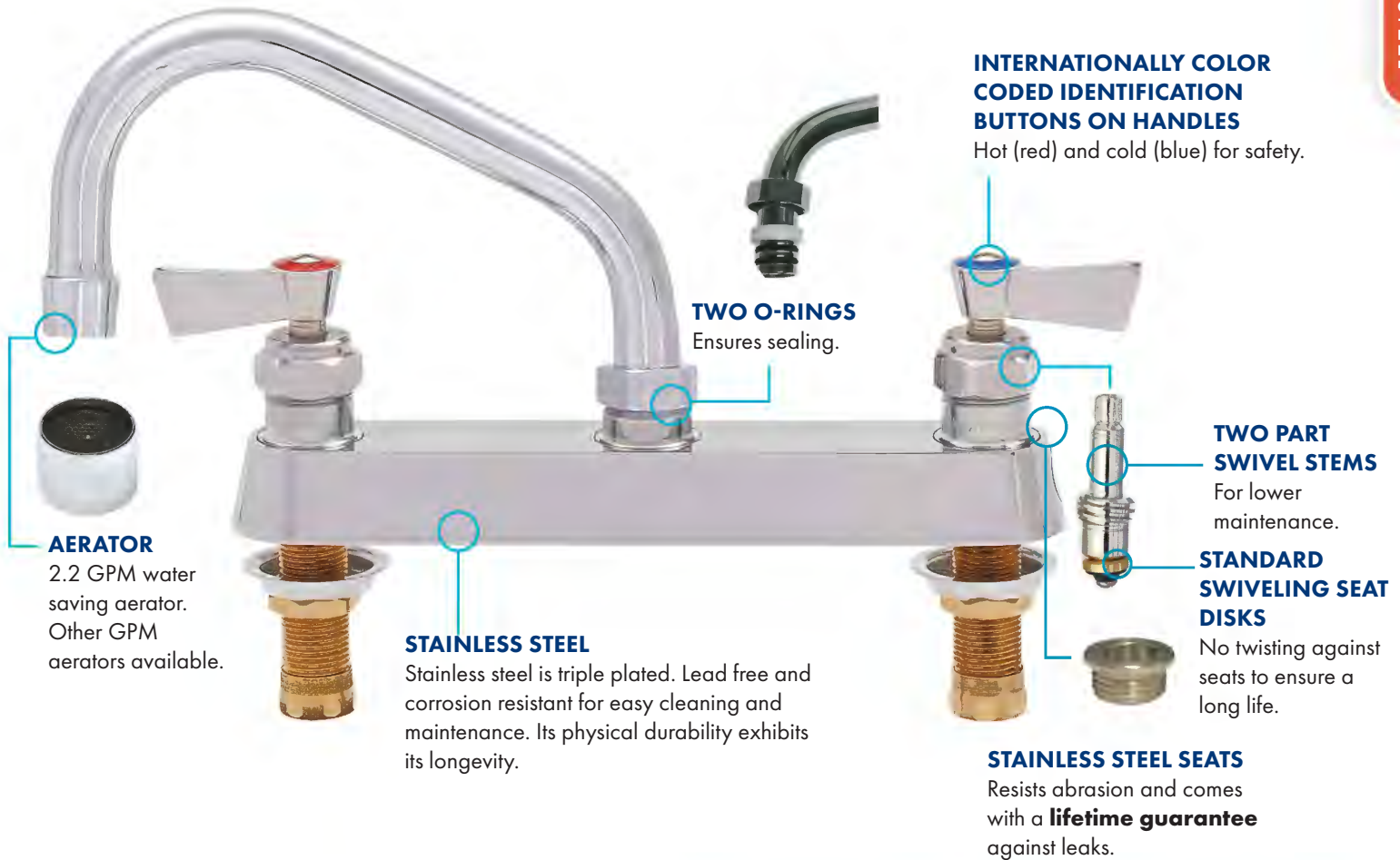

SPOUT CHOICES



HANDLE TYPES



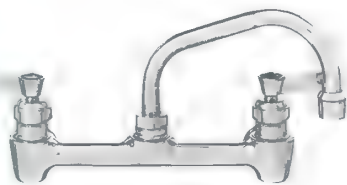

8" BACKSPLASH SINK FAUCETS

STAINLESS	DESCRIPTION
61220	8" BACKSPLASH W/ 6" SWING SPOUT
60836	8" BACKSPLASH W/ 12" SWING SPOUT
61204	8" BACKSPLASH W/ 6" SWING SPOUT & EZ INSTALL ADAPTERS
60801	8" BACKSPLASH W/ 12" SWING SPOUT & EZ INSTALL ADAPTERS
ACCESSORIES	
54461	07" DOUBLE JOINTED SPOUT
71447	CLOSE ELBOWS (2 EACH)
64351	SUPPLY LINES 1/2" F X 1/2" M X 36" LONG 2 EACH (REQUIRES CLOSE ELBOWS)



8" DECK SINK FAUCETS

STAINLESS	DESCRIPTION
57630	8" DECK W/ 6" SWING SPOUT
57665	8" DECK W/ 12" SWING SPOUT
ACCESSORIES	
75625	SUPPLY LINES 1/2" F X 1/2" F X 36" LONG (2 EACH)
54461	07" DOUBLE JOINTED SPOUT

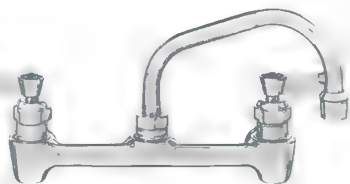

8" ADJ. WALL SINK FAUCETS

STAINLESS	DESCRIPTION
53104	8" ADJ. WALL W/ 6" SWING SPOUT
53139	8" ADJ. WALL W/ 12" SWING SPOUT
ACCESSORIES	
54461	07" DOUBLE JOINTED SPOUT
71439	BACKSPLASH MOUNTING CLOSE NIPPLES 1/2" (2 EACH)
71447	CLOSE ELBOWS 1/2" 2 EACH (REQUIRES BACKSPLASH MOUNTING NIPPLES)
64351	SUPPLY LINES 1/2" F X 1/2" M X 36" LONG 2 EACH (REQUIRES CLOSE ELBOWS)



DUAL DECK SINK FAUCETS

STAINLESS	DESCRIPTION
52760	DUAL DECK W/ 6" SWING SPOUT
52795	DUAL DECK W/ 12" SWING SPOUT
ACCESSORIES	
54461	07" DOUBLE JOINTED SPOUT

4" BACKSPLASH SINK FAUCETS



STAINLESS	DESCRIPTION
62448	4" BACKSPLASH W/ 6" SWING SPOUT
62049	4" BACKSPLASH W/ 12" SWING SPOUT
ACCESSORIES	
54461	07" DOUBLE JOINTED SPOUT
71447	CLOSE ELBOWS 1/2" (2 EACH)
64351	SUPPLY LINES 1/2" F X 1/2" M X 36" LONG 2 EACH (REQUIRES CLOSE ELBOWS)

4" DECK SINK FAUCETS



STAINLESS	DESCRIPTION
53740	4" DECK W/ 6" SWING SPOUT
53775	4" DECK W/ 12" SWING SPOUT
ACCESSORIES	
54461	07" DOUBLE JOINTED SPOUT
75625	SUPPLY LINES 1/2" F X 1/2" F X 36" LONG (2 EACH)

SINGLE WALL/BACKSPLASH SINK FAUCETS



STAINLESS	DESCRIPTION
67601	SINGLE WALL/BACKSPLASH W/ 6" SWING SPOUT
67644	SINGLE WALL/BACKSPLASH W/ 12" SWING SPOUT
ACCESSORIES	
54461	07" DOUBLE JOINTED SPOUT
71498	CLOSE ELBOW 1/2"
10006	SUPPLY LINES 1/2" F X 1/2" M X 36" LONG (REQUIRES CLOSE ELBOW)

*INCLUDES NIPPLE FOR BACKSPLASH MOUNTING

SINGLE DECK SINK FAUCETS



STAINLESS	DESCRIPTION
58009	SINGLE DECK W/ 6" SWING SPOUT
58033	SINGLE DECK W/ 12" SWING SPOUT
ACCESSORIES	
54461	07" DOUBLE JOINTED SPOUT
10022	SUPPLY LINES 1/2" F X 1/2" F X 36" LONG



4" BACKSPLASH BAR & HAND SINK FAUCETS

STAINLESS		DESCRIPTION
62669		4" BACKSPLASH W/ 6" SWIVEL / RIGID GOOSENECK SPOUT
62502		4" BACKSPLASH W/ 12" SWIVEL / RIGID GOOSENECK SPOUT
ACCESSORIES		
71447		CLOSE ELBOWS 1/2" (2 EACH)
64351		SUPPLY LINES 1/2" F X 1/2" M X 36" LONG 2 EACH (REQUIRES CLOSE ELBOWS)



4" BACKSPLASH BAR & HAND SINK FAUCETS

STAINLESS		DESCRIPTION
62677		4" BACKSPLASH W/6" SWIVEL/RIGID GOOSENECK SPOUT & WRIST HANDLES
ACCESSORIES		
64351		SUPPLY LINES 1/2" F X 1/2" M X 36" LONG (2 EACH)
71447		CLOSE ELBOW 1/2" (2 EACH)



4" DECK BAR & HAND SINK FAUCETS

STAINLESS		DESCRIPTION
53872		4" DECK W/ 6" SWIVEL / RIGID GOOSENECK SPOUT
53880		4" DECK W/ 12" SWIVEL / RIGID GOOSENECK SPOUT
ACCESSORIES		
75625		SUPPLY LINES 1/2" F X 1/2" F X 36" LONG (2 EACH)



4" DECK BAR & HAND SINK FAUCETS

STAINLESS		DESCRIPTION
58696		4" DECK W/6" SWIVEL/RIGID GOOSENECK SPOUT & WRIST HANDLES
ACCESSORIES		
75625		SUPPLY LINES 1/2" F X 1/2" F X 36" LONG (2 EACH)



DUAL DECK BAR & HAND SINK FAUCETS

STAINLESS		DESCRIPTION
52892		DUAL DECK W/ 6" SWIVEL / RIGID GOOSENECK SPOUT
52906		DUAL DECK W/ 12" SWIVEL / RIGID GOOSENECK SPOUT

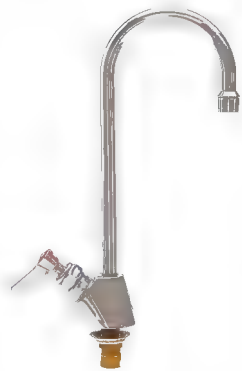

SINGLE DECK BAR & HAND SINK BASES

STAINLESS	DESCRIPTION
58130	SINGLE DECK W/ 6" SWIVEL / RIGID GOOSENECK SPOUT
58149	SINGLE DECK W/ 12" SWIVEL / RIGID GOOSENECK SPOUT
ACCESSORIES	
10022	SUPPLY LINES 1/2" X 1/2" X 36" LONG



BACKSPLASH BAR & HAND SINK BASES

STAINLESS	DESCRIPTION
47090	BACKSPLASH BASE W/ 6" SWIVEL / RIGID GOOSENECK SPOUT
47104	BACKSPLASH BASE W/ 12" SWIVEL / RIGID GOOSENECK SPOUT
ACCESSORIES	
71498	CLOSE ELBOW 1/2"
10006	SUPPLY LINES 1/2" X 1/2" X 36" LONG (REQUIRES CLOSE ELBOW)

*INCLUDES NIPPLE FOR BACKSPLASH MOUNTING



DECK BASE BAR & HAND SINK BASES

STAINLESS	DESCRIPTION
45748	DECK BASE W/ 6" SWIVEL / RIGID GOOSENECK SPOUT
46094	DECK BASE W/ 12" SWIVEL / RIGID GOOSENECK SPOUT
ACCESSORIES	
10022	SUPPLY LINES 1/2" X 1/2" X 36" LONG



8" ADJ. POT FILLER FAUCETS

STAINLESS	DESCRIPTION
54100	8" ADJ. WALL W/ 12" POT FILLER SPOUT & 07" DOUBLE JOINTED SPOUT
54801	8" ADJ. WALL W/ 12" POT FILLER SPOUT & 12" DOUBLE JOINTED SPOUT
ACCESSORIES	
71439	BACKSPLASH 1/2" MOUNTING CLOSE NIPPLE (2 EACH)
71447	CLOSE ELBOWS 1/2" (REQUIRES BACKSPLASH MOUNTING NIPPLES) (2 EACH)
64351	SUPPLY LINES 1/2F X 1/2M X 36" LONG (REQUIRES CLOSE ELBOWS) (2 EACH)



SINGLE WALL/BACKSPLASH POT FILLER FAUCETS

STAINLESS	DESCRIPTION
69175	SINGLE WALL / BACKSPLASH W/ 12" POT FILLER SPOUT & 07" DOUBLE JOINTED SPOUT
69183	SINGLE WALL / BACKSPLASH W/ 12" POT FILLER SPOUT & 12" DOUBLE JOINTED SPOUT
ACCESSORIES	
71498	CLOSE ELBOW 1/2"
10006	SUPPLY LINES 1/2F X 1/2M X 36" LONG (REQUIRES CLOSE ELBOWS)

*INCLUDES NIPPLE FOR BACKSPLASH MOUNTING



8" BACKSPASH CONTROL VALVE

STAINLESS LEVER HANDLES	DESCRIPTION
61549	SWIVEL OUTLET / SWIVEL STEMS



8" DECK CONTROL VALVE

STAINLESS LEVER HANDLES	DESCRIPTION
67385	SWIVEL OUTLET / SWIVEL STEMS



8" ADJ. WALL CONTROL VALVE

STAINLESS LEVER HANDLES	DESCRIPTION
61565	SWIVEL OUTLET / SWIVEL STEMS
23698	SWIVEL OUTLET / CHECK STEMS



4" BACKSPASH CONTROL VALVE

STAINLESS LEVER HANDLES	DESCRIPTION
62839	SWIVEL OUTLET / SWIVEL STEMS



4" DECK CONTROL VALVE

STAINLESS LEVER HANDLES	DESCRIPTION
67423	SWIVEL OUTLET / SWIVEL STEMS

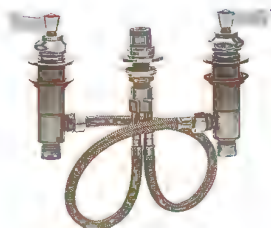

WIDESPREAD CONTROL VALVE

STAINLESS LEVER HANDLES	DESCRIPTION
70173	SWIVEL OUTLET / SWIVEL STEMS



DUAL DECK CONTROL VALVE

STAINLESS LEVER HANDLES	DESCRIPTION
63592	SWIVEL OUTLET / SWIVEL STEMS



SINGLE WALL / BACKSPASH CONTROL VALVE

STAINLESS LEVER HANDLES	DESCRIPTION
70459	SWIVEL OUTLET / SWIVEL STEMS
70432	3/8" FEMALE OUTLET / SWIVEL STEMS

* INCLUDES NIPPLE FOR BACKSPALSH MOUNTING



SINGLE DECK CONTROL VALVE

STAINLESS LEVER HANDLES	DESCRIPTION
66575	SWIVEL OUTLET / SWIVEL STEMS
66591	3/8" FEMALE OUTLET / SWIVEL STEMS

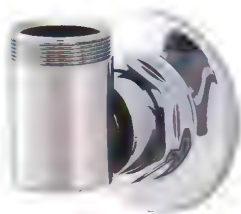

SINGLE BACKSPASH BASE

STAINLESS LEVER HANDLES	DESCRIPTION
3900	SWIVEL OUTLET

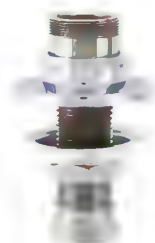

SINGLE DECK BASE

STAINLESS LEVER HANDLES	DESCRIPTION
3800	SWIVEL OUTLET
2903	3/8" FEMALE OUTLET

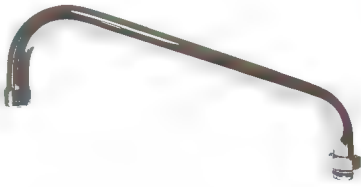

1/2" SWING SPOUTS

STAINLESS	DESCRIPTION
54380	6" SWING SPOUT
54399	8" SWING SPOUT
54402	10" SWING SPOUT
54410	12" SWING SPOUT
54429	14" SWING SPOUT
54445	16" SWING SPOUT

* SPOUT REQUIRE CONTROL VALVES WITH SWIVEL OUTLET AND SWIVEL STEMS



1/2" SWIVEL DOUBLE JOINT

STAINLESS	DESCRIPTION
54461	7" SWIVEL DOUBLE JOINT
55050	12" SWIVEL DOUBLE JOINT

* DJ'S REQUIRE CONTROL VALVES WITH SWIVEL OUTLETS



1/2" SWIVEL / RIGID GOOSENECK SPOUTS

STAINLESS	DESCRIPTION
54453	6" SWIVEL / RIGID GOOSENECK SPOUT
54437	12" SWIVEL / RIGID GOOSENECK SPOUT

* SPOUT REQUIRE CONTROL VALVES WITH SWIVEL OUTLET AND SWIVEL STEMS



1/2" SWIVEL CONTROL SPOUTS

STAINLESS	DESCRIPTION
55042	12" SWIVEL CONTROL SPOUT

* SPOUT REQUIRE CONTROL VALVES WITH SWIVEL OUTLET AND CHECK STEMS



BACKSPLASH MOUNTING NIPPLES FOR WALL FAUCETS

STAINLESS	DESCRIPTION
71439	BACKSPLASH MOUNTING CLOSE NIPPLES 1/2" FOR WALL FAUCETS (2 EACH)



ELBOWS FOR WALL FAUCETS

STAINLESS	DESCRIPTION
71498	CLOSE ELBOW FOR BACKSPLASH CONTROL VALVE OR WALL CONTROL VALVE WITH BACKSPLASH MOUNTING NIPPLE 1/2"
71447	CLOSE ELBOWS FOR BACKSPLASH CONTROL VALVES OR WALL CONTROL VALVES WITH BACKSPLASH MOUNTING NIPPLES 1/2" (2 EACH)



SUPPLY LINES

STAINLESS	DESCRIPTION
10006	SUPPLY LINE 1/2" FEMALE X 1/2" FEMALE X 36" LONG FOR DECK MOUNT CONTROL VALVES AND BASES (2 EACH)
64351	SUPPLY LINE 1/2" FEMALE X 1/2" MALE X 36" LONG FOR BACKSPLASH MOUNTED CONTROL VALVES WITH ELBOWS (2 EACH)
10022	SUPPLY LINE 1/2" FEMALE X 1/2" FEMALE X 36" LONG FOR DECK MOUNT CONTROL VALVE AND BASE
75625	SUPPLY LINE 1/2" FEMALE X 1/2" FEMALE X 36" LONG FOR DECK MOUNT CONTROL VALVES AND BASES (2 EACH)



KETTLE FILLER RISERS

STAINLESS	DESCRIPTION
38326	2" RISER
38334	4" RISER
71315	16" RISER
63363	21" RISER

*RISERS REQUIRE SWIVEL ADAPTER & CONTROL VALVES WITH RIGID OUTLETS

1/2" PRE-RINSE UNITS - STAINLESS STEEL

Save thousands of dollars in utility bills by equipping your commercial kitchen with one of our innovative Fisher Pre-Rinse Units. Each unit features the water saving Ultra Spray Valve Plus and new Chemical Tee. Fisher now offers a 10 year warranty on stainless steel.

CHECK OUT THESE PRE-RINSE FEATURES:



EXTRA COIL DENSITY

Provides enhanced protection against hose and armor fatigue at critical points.

UNIVERSAL DESIGN

Fits ALL brands.

MULTI-COIL DESIGN

Enhanced at both ends.

CHEM TEE

Less obstruction - no need for a longer hose. The flush mount 3/8" NPT plug is included. The chemical port connection ensures easy installation for a reduced cost in labor.



WALL BRACKET

Secures the pre-rinse unit to the wall with 3 set screws to provide reinforcement and stability while also being adjustable.



INTERNATIONALLY COLOR CODED IDENTIFICATION BUTTONS ON HANDLES

Hot (red) and cold (blue) for safety.



3-PLY AIRCRAFT HYDRAULIC INNER HOSE

Last three times longer than the competition.

EXTENDED LENGTH THREADED INSERT

Securely seals the interior hose.

STAINLESS STEEL ARMOR JACKET

Relieves tension and abrasion on the interior hose to provide a longer service life.

INSULATED HANDLE

Heat resistant brass alloy handle rubber dipped for added protection.



ULTRA SPRAY VALVE

STANDARD PROTECTIVE FULL-SURROUNDING DISH GUARD BUMPER

Eliminates leaking.

PTFE-DISC FOR SMOOTHER ACTION

1.15 GPM Knife Edge spray nozzle

Guaranteed for 1 million cycles!

HEAVY DUTY LIFT PIN

The two o-rings ensure a proper seal.

FITS ALL BRANDS OF HOSES

TWO PART CHECK STEM

For the prevention of cross flow and lower maintenance.

STAINLESS STEEL SEATS

Resists abrasion and comes with a lifetime guarantee against leaks.

STAINLESS STEEL BODY

Lead free and corrosion resistant for easy cleaning and maintenance. Its physical durability exhibits its longevity.

SWIVEL STYLE OPTIONS



SWIVEL STYLE

The long swivel arm provides maximum reach and a superior range of motion.

PRE-RINSE CRITICAL POINTS

Overall height from base of faucet

Spring Style - 38"

Swivel Style - 38"

Mini Style - 22 3/8"

Distance from bottom of spray valve to bottom of faucet:

Spring Style - 12"

Swivel Style - 7"

Mini Style - 7 5/8"



8" BACKSPLASH SPRING STYLE PRE-RINSE

STAINLESS		DESCRIPTION
67989		8" BACKSPLASH SPRING STYLE PRE-RINSE & ULTRA SPRAY PLUS
52922		8" BACKSPLASH SPRING STYLE PRE-RINSE & ULTRA SPRAY PLUS WITH EZ INSTALL ADAPTERS
ACCESSORIES		
71447		CLOSE ELBOWS (2 EACH)
64351		SUPPLY LINES 1/2" F X 1/2" M X 36" LONG (2 EACH. REQUIRES CLOSE ELBOWS)
2949-9001		SPRAY VALVE BRUSH
2932-0002		DUAL CHECK VACUUM BREAKER 3/4"-14 FEMALE X 3/4"-14 MALE



8" BACKSPLASH SPRING STYLE PRE-RINSE W/ ADD ON FAUCET

STAINLESS		DESCRIPTION
68071		8" BACKSPLASH SPRING STYLE PRE-RINSE W/ ADD-ON FAUCET, ULTRA SPRAY VALVE PLUS & 6" SWING SPOUT
68128		8" BACKSPLASH SPRING STYLE PRE-RINSE W/ ADD-ON FAUCET, ULTRA SPRAY VALVE PLUS & 12" SWING SPOUT
52930		8" BACKSPLASH SPRING STYLE PRE-RINSE W/ ADD-ON FAUCET, ULTRA SPRAY VALVE PLUS & 6" SWING SPOUT WITH EZ INSTALL ADAPTERS
52965		8" BACKSPLASH SPRING STYLE PRE-RINSE W/ ADD-ON FAUCET, ULTRA SPRAY VALVE PLUS & 12" SWING SPOUT WITH EZ INSTALL ADAPTERS
ACCESSORIES		
71447		CLOSE ELBOWS (2 EACH)
64351		SUPPLY LINES 1/2" F X 1/2" M X 36" LONG (2 EACH. REQUIRES CLOSE ELBOWS)
2949-9001		SPRAY VALVE BRUSH
2932-0002		DUAL CHECK VACUUM BREAKER 3/4"-14 FEMALE X 3/4"-14 MALE



8" DECK SPRING STYLE PRE-RINSE

STAINLESS		DESCRIPTION
68217		8" DECK SPRING STYLE PRE-RINSE & ULTRA SPRAY PLUS
ACCESSORIES		
75625		SUPPLY LINES 1/2" F X 1/2" F X 36" LONG (2 EACH)
2949-9001		SPRAY VALVE BRUSH
2932-0002		DUAL CHECK VACUUM BREAKER 3/4"-14 FEMALE X 3/4"-14 MALE



8" DECK SPRING STYLE PRE-RINSE W/ ADD ON FAUCET

STAINLESS		DESCRIPTION
68225		8" DECK SPRING STYLE PRE-RINSE W/ ADD ON FAUCET, ULTRA SPRAY VALVE PLUS & 6" SWING SPOUT
68268		8" DECK SPRING STYLE PRE-RINSE W/ ADD ON FAUCET, ULTRA SPRAY VALVE PLUS & 12" SWING SPOUT
ACCESSORIES		
75625		SUPPLY LINES 1/2" F X 1/2" F X 36" LONG (2 EACH)
2949-9001		SPRAY VALVE BRUSH
2932-0002		DUAL CHECK VACUUM BREAKER 3/4"-14 FEMALE X 3/4"-14 MALE



8" ADJ. WALL SPRING STYLE PRE-RINSE

STAINLESS	DESCRIPTION
53430	8" ADJ. WALL SPRING STYLE PRE-RINSE & ULTRA SPRAY PLUS
ACCESSORIES	
71439	BACKSPLASH MOUNTING NIPPLES (2 EACH)
71447	CLOSE ELBOWS (2 EACH. REQUIRES BACKSPLASH MOUNTING NIPPLES)
64351	SUPPLY LINES 1/2" F X 1/2" M X 36" LONG (2 EACH. REQUIRES CLOSE ELBOWS)
2949-9001	SPRAY VALVE BRUSH
2932-0002	DUAL CHECK VACUUM BREAKER 3/4"-14 FEMALE X 3/4"-14 MALE



8" ADJ. WALL SPRING STYLE PRE-RINSE W/ ADD ON FAUCET

STAINLESS	DESCRIPTION
53449	8" ADJ. WALL SPRING STYLE PRE-RINSE W/ ADD ON FAUCET, ULTRA SPRAY VALVE PLUS & 6" SWING SPOUT
53473	8" ADJ. WALL SPRING STYLE PRE-RINSE W/ ADD ON FAUCET, ULTRA SPRAY VALVE PLUS & 12" SWING SPOUT
ACCESSORIES	
71439	BACKSPLASH MOUNTING NIPPLES (2 EACH)
71447	CLOSE ELBOWS (2 EACH. REQUIRES BACKSPLASH MOUNTING NIPPLES)
64351	SUPPLY LINES 1/2" F X 1/2" M X 36" LONG (2 EACH. REQUIRES CLOSE ELBOWS)
2949-9001	SPRAY VALVE BRUSH
2932-0002	DUAL CHECK VACUUM BREAKER 3/4"-14 FEMALE X 3/4"-14 MALE



DUAL DECK SPRING STYLE PRE-RINSE

STAINLESS	DESCRIPTION
53007	DUAL DECK SPRING STYLE PRE-RINSE & ULTRA SPRAY PLUS
ACCESSORIES	
2949-9001	SPRAY VALVE BRUSH
2932-0002	DUAL CHECK VACUUM BREAKER 3/4"-14 FEMALE X 3/4"-14 MALE



DUAL DECK SPRING STYLE PRE-RINSE W/ ADD ON FAUCET

STAINLESS	DESCRIPTION
53015	DUAL DECK SPRING STYLE PRE-RINSE W/ ADD ON FAUCET, ULTRA SPRAY VALVE PLUS & 6" SWING SPOUT
53058	DUAL DECK SPRING STYLE PRE-RINSE W/ ADD ON FAUCET, ULTRA SPRAY VALVE PLUS & 12" SWING SPOUT
ACCESSORIES	
2949-9001	SPRAY VALVE BRUSH
2932-0002	DUAL CHECK VACUUM BREAKER 3/4"-14 FEMALE X 3/4"-14 MALE



8" BACKSPASH CONTROL VALVE

STAINLESS LEVER HANDLES	DESCRIPTION
61662	3/8" FEMALE OUTLET / CHECK STEMS



8" DECK CONTROL VALVE

STAINLESS LEVER HANDLES	DESCRIPTION
67407	3/8" FEMALE OUTLET / CHECK STEMS



8" ADJ. WALL CONTROL VALVE

STAINLESS LEVER HANDLES	DESCRIPTION
61689	3/8" FEMALE OUTLET / CHECK STEMS



4" BACKSPASH CONTROL VALVE

STAINLESS LEVER HANDLES	DESCRIPTION
62936	3/8" FEMALE OUTLET / CHECK STEMS

* FAUCET BASE USED AS AN OPTION FOR PRE-RINSE



4" DECK CONTROL VALVE

STAINLESS LEVER HANDLES	DESCRIPTION
67458	3/8" FEMALE OUTLET / CHECK STEMS

* FAUCET BASE USED AS AN OPTION FOR PRE-RINSE



DUAL DECK CONTROL VALVE

STAINLESS LEVER HANDLES	DESCRIPTION
63134	3/8" FEMALE OUTLET / CHECK STEMS



SINGLE WALL / BACKSPASH CONTROL VALVE

STAINLESS LEVER HANDLES	DESCRIPTION
70432	3/8" FEMALE OUTLET / CHECK STEMS

* FAUCET BASE USED AS AN OPTION FOR PRE-RINSE



SINGLE DECK CONTROL VALVE

STAINLESS LEVER HANDLES WITH 4" REMOTE CONTROL	DESCRIPTION RINSE
66591	3/8" FEMALE OUTLET / CHECK STEMS

* FAUCET BASE USED AS AN OPTION FOR PRE-RINSE

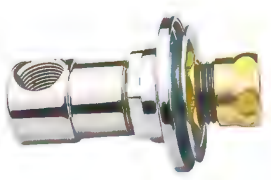

SINGLE BACKSPASH BASE

STAINLESS LEVER HANDLES	DESCRIPTION
3900-0002	3/8" FEMALE OUTLET



SINGLE DECK BASE

STAINLESS LEVER HANDLES	DESCRIPTION
2903	3/8" FEMALE OUTLET

* FAUCET USED AS AN OPTION WITH 4" REMOTE CONTROL VALVE FOR PRE-RINSE



PRE-RINSE SPRING STYLE SUB-ASSEMBLY

STAINLESS	DESCRIPTION
32697	SPRING STYLE SUB-ASSEMBLY W/ ULTRA SPRAY VALVE & 16" RISER FOR PRE-RINSES WITH ADD-ON FAUCETS
38660	SPRING STYLE SUB-ASSEMBLY W/ ULTRA SPRAY VALVE & 21" RISER FOR PRE-RINSES WITHOUT ADD-ON FAUCETS
75596	SPRING STYLE SUB-ASSEMBLY W/ ULTRA SPRAY VALVE 7 PLUS & 16" RISER FOR PRE-RINSES WITH ADD-ON FAUCETS
75597	SPRING STYLE SUB-ASSEMBLY W/ ULTRA SPRAY VALVE 7 PLUS & 21" RISER FOR PRE-RINSES WITHOUT ADD-ON FAUCETS

* INCLUDES ADAPTER TO ASSEMBLE TO T&S CONTROL VALVES

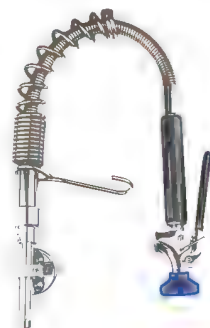

PRE-RINSE MINI SPRING STYLE SUB-ASSEMBLY

STAINLESS	DESCRIPTION
75411	MINI SPRING STYLE SUB-ASSEMBLY W/ ULTRA SPRAY VALVE & 4" RISER FOR PRE-RINSES WITH ADD-ON FAUCETS
75600	MINI SPRING STYLE SUB-ASSEMBLY W/ ULTRA SPRAY VALVE 7 PLUS & 4" RISER FOR PRE-RINSES WITH ADD-ON FAUCETS

* INCLUDES ADAPTER TO ASSEMBLE TO T&S CONTROL VALVES

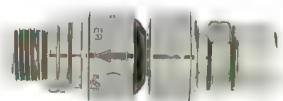

DUAL CHECK VALVES & VACUUM BREAKERS

STAINLESS	DESCRIPTION
2932-0002	DUAL CHECK VACUUM BREAKER 3/4"-14 FEMALE X 3/4"-14 MALE



NIPPLES FOR ADJ. WALL PRE-RINSES

STAINLESS	DESCRIPTION
71439	NIPPLES FOR 1/2" ADJ. WALL PRE-RINSES 1/2" NPT MALE X 1/2" NPT MALE X 1 3/4" LONG W/ SLIP JOINT KIT (2 EACH)
70645	NIPPLE FOR 1/2" ADJ WALL PRE-RINSES 1/2" NPT MALE X 1/2" NPT MALE X 1 3/4" LONG W/SLIP JOINT KIT



ELBOWS FOR ADJ. WALL W/ NIPPLE & BACKSPLASH PRE-RINSE

STAINLESS	DESCRIPTION
71498	ELBOW FOR 1/2" WALL W/ NIPPLES & BACKSPLASH PRE-RINSES 1/2" NPT FEMALE X 1/2" NPT FEMALE
71447	ELBOWS FOR 1/2" WALL W/ NIPPLES & BACKSPLASH PRE-RINSES 1/2" NPT FEMALE X 1/2" NPT FEMALE (2 EACH)



SUPPLY LINES FOR 1/2" PRE-RINSE UNITS

STAINLESS	DESCRIPTION
10006	SUPPLY LINES FOR 1/2" PRE-RINSES 1/2" FEMALE X 1/2" MALE X 36" LONG
64351	SUPPLY LINES FOR 1/2" PRE-RINSES 1/2" FEMALE X 1/2" MALE X 36" LONG (2 EACH)
10022	SUPPLY LINES FOR 1/2" PRE-RINSES 1/2" FEMALE X 1/2" FEMALE X 36" LONG
75625	SUPPLY LINES FOR 1/2" PRE-RINSES 1/2" FEMALE X 1/2" FEMALE X 36" LONG (2 EACH)



SPRAY VALVE BRUSH

STAINLESS	DESCRIPTION
2949-9001	SPRAY VALVE BRUSH



1/2" SWING SPOUTS FOR ADD-ON FAUCET

STAINLESS	DESCRIPTION
54380	6" SWING SPOUT
54399	8" SWING SPOUT
54402	10" SWING SPOUT
54410	12" SWING SPOUT
54429	14" SWING SPOUT
54445	16" SWING SPOUT



ADD-ON FAUCETS

STAINLESS	DESCRIPTION
71323	ADD-ON FAUCET W/ 4" RISER W/ 6" SPOUT
71366	ADD-ON FAUCET W/ 4" RISER W/ 12" SPOUT
38318	ADD-ON FAUCET W/ 4" RISER LESS SPOUT

THIS PAGE INTENTIONALLY BLANK

FOOT AND KNEE VALVES - STAINLESS STEEL

Fisher foot/knee valves are a perfect solution for going hands free. They have self-closing, foot operated valves that eliminate the possibility of contamination from germ-laden or dirty dishes. They are easy to operate and are available in single or double valves for easy floor, wall, or knee heights installations. Ideal for restaurants, hospitals, schools, hotels, restrooms, and more. Fisher now has a 10 year warranty on stainless steel.

CHECK OUT THESE FOOT/KNEE VALVE FEATURES:

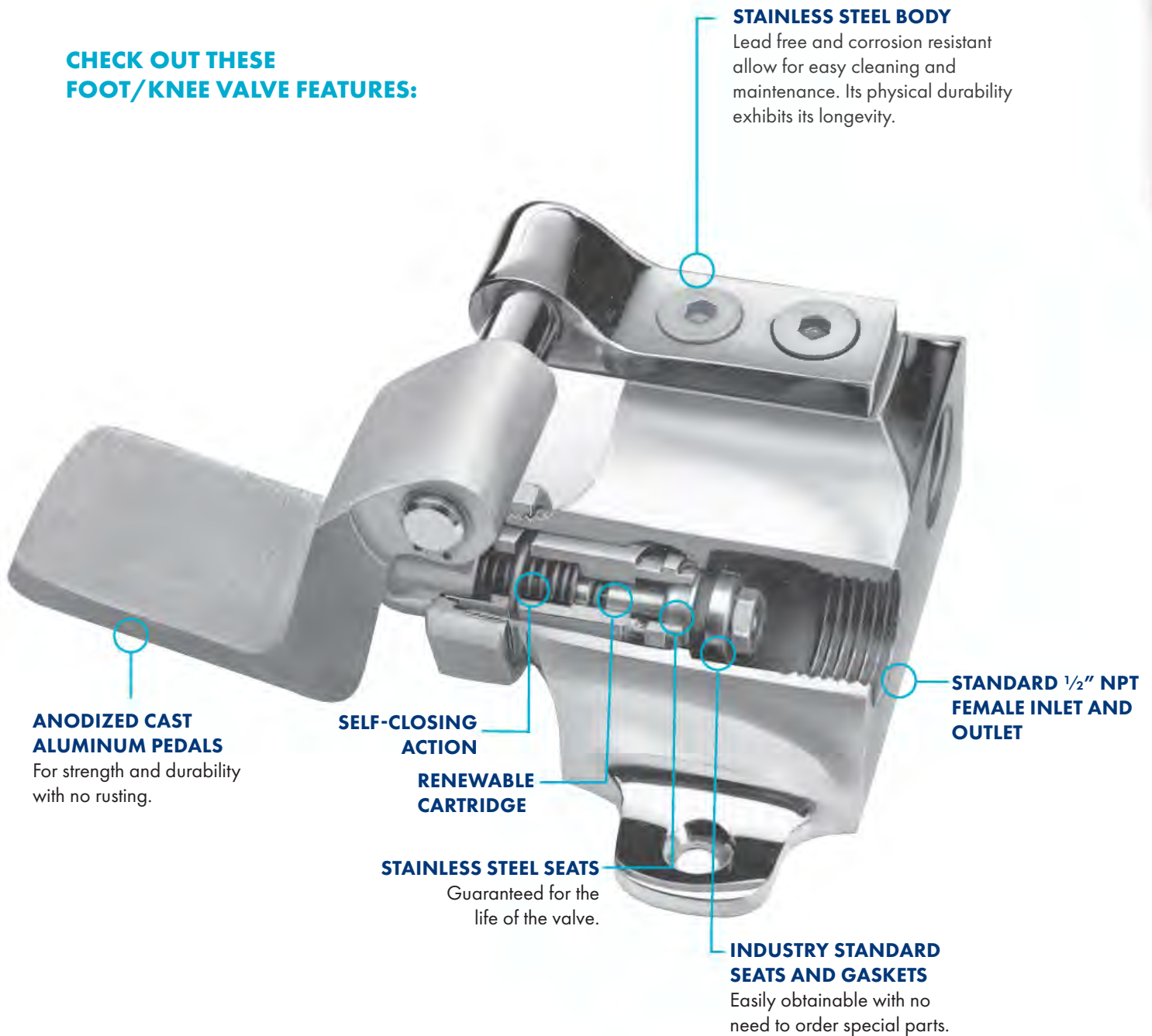



SINGLE PEDAL UNDER SINK MOUNT KNEE VALVE

STAINLESS	DESCRIPTION
48011	SINGLE PEDAL UNDER SINK MOUNT KNEE VALVE



SINGLE PEDAL FLOOR MOUNT FOOT VALVE

STAINLESS	DESCRIPTION
47759	SINGLE PEDAL FLOOR MOUNT FOOT VALVE



SINGLE PEDAL WALL MOUNT FOOT VALVE

STAINLESS	DESCRIPTION
48062	SINGLE PEDAL VALVE WALL MOUNT FOOT VALVE



DUAL PEDAL UNDER SINK MOUNT KNEE VALVE

STAINLESS	DESCRIPTION
48054	DUAL PEDAL UNDER SINK MOUNT KNEE VALVE



DUAL PEDAL FLOOR MOUNT FOOT VALVE

STAINLESS	DESCRIPTION
47988	DUAL Pedal Floor Mount Foot Valve



DUAL PEDAL WALL MOUNT FOOT VALVE

STAINLESS	DESCRIPTION
48070	DUAL PEDAL WALL MOUNT FOOT VALVE



BACKSPLASH BAR & HAND SINK BASES

STAINLESS	DESCRIPTION
47090	BACKSPLASH BASE W/ 6" SWIVEL / RIGID GOOSENECK SPOUT
47104	BACKSPLASH BASE W/ 12" SWIVEL / RIGID GOOSENECK SPOUT
COMPONENTS	
71498	CLOSE ELBOW 1/2"
10006	SUPPLY LINE 1/2" F X 1/2" M X 36" LONG (REQUIRES CLOSE ELBOW)

DECK BAR & HAND SINK BASES

STAINLESS	DESCRIPTION
45748	DECK BASE W/ 6" SWIVEL / RIGID GOOSENECK SPOUT
46094	DECK BASE W/ 12" SWIVEL / RIGID GOOSENECK SPOUT
COMPONENTS	
10022	SUPPLY LINE 1/2" F X 1/2" F X 36" LONG (REQUIRES CLOSE ELBOW)

GLASS FILLER - STAINLESS STEEL

Fisher glass fillers feature great looks with a simplistic design and high quality construction for a long service life. They are available in your choice of models to meet virtually any water service installation and need. They are ideal for restaurants, schools, healthcare facilities, grocery/retail facilities, hospitality facilities, and convenience stores. Fisher now has a 10 year warranty on stainless steel.

CHECK OUT THESE GLASS FILLER FEATURES:

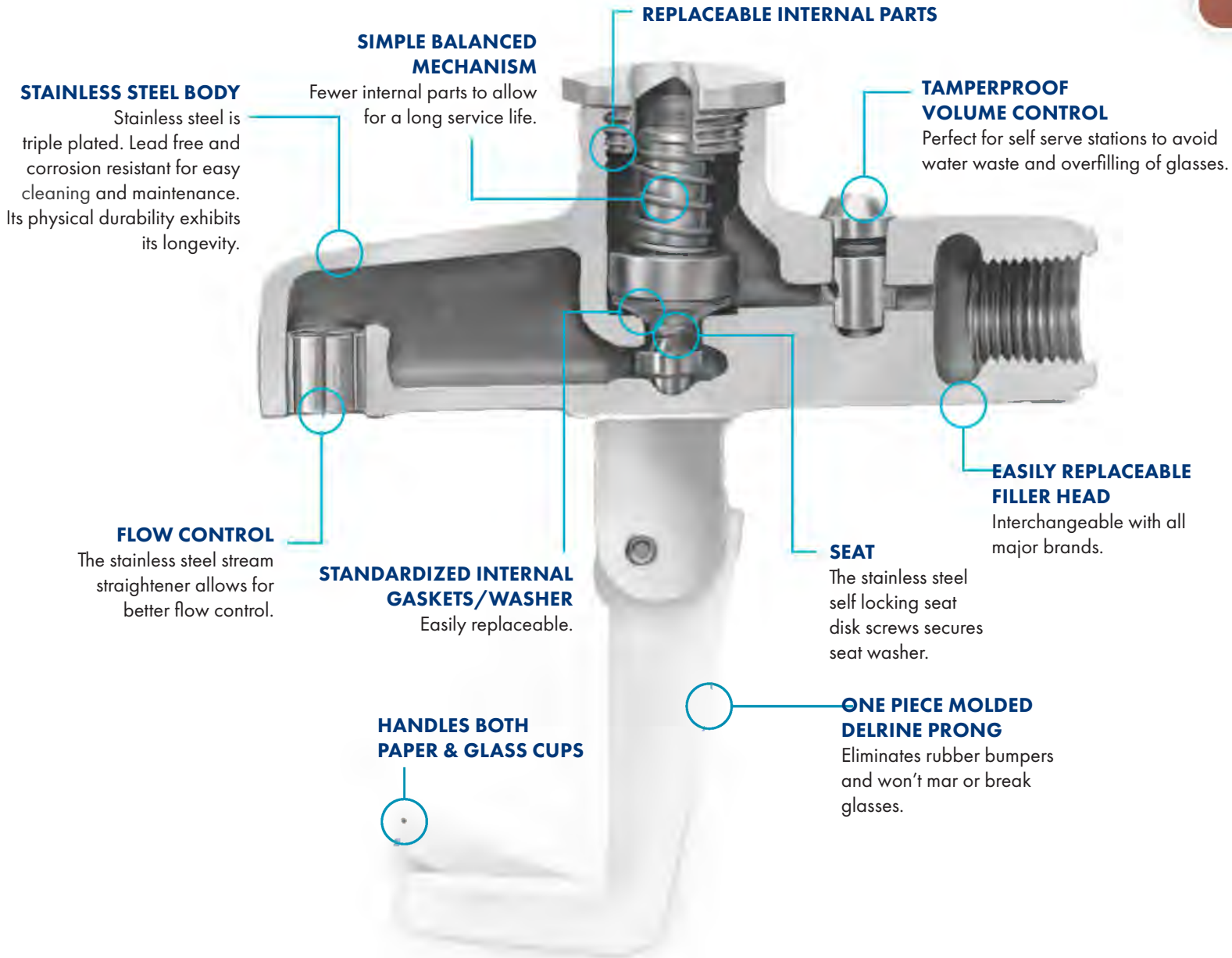

STAINLESS STEEL BODY

Stainless steel is triple plated. Lead free and corrosion resistant for easy cleaning and maintenance. Its physical durability exhibits its longevity.

SIMPLE BALANCED MECHANISM

Fewer internal parts to allow for a long service life.

REPLACEABLE INTERNAL PARTS

TAMPERPROOF VOLUME CONTROL

Perfect for self serve stations to avoid water waste and overfilling of glasses.

FLOW CONTROL

The stainless steel stream straightener allows for better flow control.

STANDARDIZED INTERNAL GASKETS/WASHER

Easily replaceable.

EASILY REPLACEABLE FILLER HEAD

Interchangeable with all major brands.

SEAT

The stainless steel self locking seat disk screws secures seat washer.

HANDLES BOTH PAPER & GLASS CUPS

ONE PIECE MOLDED DELRINE PRONG

Eliminates rubber bumpers and won't mar or break glasses.

**ANSI/NSF 61,
SECTION 9 CERTIFIED**



PEDESTAL GLASS FILLER

STAINLESS	DESCRIPTION
54194	8" PEDESTAL GLASS FILLER
54186	10" PEDESTAL GLASS FILLER
59099	12" PEDESTAL GLASS FILLER
59102	14" PEDESTAL GLASS FILLER



PEDESTAL GLASS FILLER W/ SINK

STAINLESS	DESCRIPTION
54208	10" PEDESTAL GLASS FILLER W/ SINK
59110	12" PEDESTAL GLASS FILLER W/ SINK
59129	14" PEDESTAL GLASS FILLER W/ SINK

ICE MACHINE GLASS FILLER

STAINLESS	DESCRIPTION
54224	GLASS FILLER ¼" FEMALE X ½" MALE W/ ¼" TUBE FITTING



REEL RINSE UNITS

Fisher reel rinse units make water conveniently available in all areas of the kitchen. Universally designed models are available for ceiling and wall mounts, as well as under counter models for added convenience. All reel rinse units are ready to install and feature 3-ply, 200 lbs. working pressure hoses. The hoses are designed to withstand a continuous operating temperature of 140°F. Installation has been simplified with Fisher's uniquely designed reel rinse control unit which combines all the necessary components into one complete system. Control valves and gauges are completely enclosed within a stainless steel cabinet with only three connections — giving the operator total tamper resistant control. Fisher now offers a 2 year warranty on Hose Reels.

NOTE: In all cases, we suggest that local plumbing codes be followed, especially in the area of cross-flow and backflow prevention.

CHECK OUT THESE HOSE REEL FEATURES:

CAFE STYLE

Cafe style is available open or closed style. Powder coated steel construction and stainless steel. Powder coated steel provides long lasting durability for maximum corrosion resistance. The Stainless Steel quality finish and corrosion resistant components offer the maximum protection from premature corrosion. It's highly durable and corrosion resistant. Reel rinse styles with ratchet lock and easy tension adjustment. Furnished with $\frac{3}{8}$ " ID hose rated at 200 PSI, and 160°F water temperature. Water inlet is $\frac{3}{8}$ " Male NPT.

INDUSTRIAL DUTY STYLE

Industrial Duty Style available open and closed style. All Stainless Steel construction, with ratchet lock and easy tension adjustment. Furnished with $\frac{1}{2}$ " or $\frac{3}{8}$ " ID hose rated at 200 PSI, and 160°F water temperature. Water inlet is $\frac{1}{2}$ " Female NPT.



Fisher's Reel Rinse Control Unit

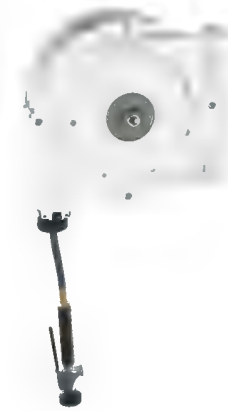

OPEN POWDER COATED STEEL REEL

ITEM	DESCRIPTION
29801	WALL MOUNT OPEN REEL W/ 30' HOSE & PRO SPRAY VALVE - WHITE ENAMEL PAINT
29662	UNDERCOUNTER MOUNT OPEN REEL W/20' HOSE & UTILITY SPRAY WHITE ENAMEL PAINT 12' SPOOL

ENCLOSED POWDER COATED STEEL REELS

ITEM	DESCRIPTION
29851	WALL MOUNT ENCLOSED REEL W/ 30' HOSE & PRO SPRAY VALVE - WHITE ENAMEL PAINT COVER PRO
32027	CEILING MOUNT ENCLOSED REEL W/ 30' HOSE & PRO SPRAY VALVE - WHITE ENAMEL PAINT COVER

OPEN STAINLESS STEEL REELS

ITEM	DESCRIPTION
75395	WALL MOUNT OPEN REEL W/ 50' HOSE & SPRAY VALVE - STAINLESS STEEL CONSTRUCTION
ACCESSORIES	
75199	SWING WALL BRACKET FOR OPEN STAINLESS STEEL CONSTRUCTED HOSE REELS
75200	PIVOT FLOOR BRACKET FOR OPEN STAINLESS STEEL CONSTRUCTED HOSE REELS

OPEN STAINLESS STEEL REEL

ITEM	DESCRIPTION
75397	WALL MOUNT OPEN REEL W/ 50' HOSE & SPRAY GUN - STAINLESS STEEL CONSTRUCTION
ACCESSORIES	
75199	SWING WALL BRACKET FOR OPEN STAINLESS STEEL CONSTRUCTED HOSE REELS
75200	PIVOT FLOOR BRACKET FOR OPEN STAINLESS STEEL CONSTRUCTED HOSE REELS



UNDER COUNTER OPEN POWDER COATED STEEL REEL

ITEM	DESCRIPTION
29841	UNDER COUNTER MOUNT OPEN REEL W/ 20' HOSE AND UTILITY SPRAY - WHITE ENAMEL PAINT 12" SPOOL
29662	UNDER COUNTER MOUNT OPEN REEL W/ 20' HOSE & PRO SPRAY VALVE WHITE ENAMEL PAINT 12" SPOOL



ENCLOSED REELS

ITEM	DESCRIPTION
75221	WALL MOUNT ENCLOSED REEL W/ 30' HOSE & SPRAY VALVE - STAINLESS STEEL COVER
75222	CEILING MOUNT ENCLOSED REEL W/ 30' HOSE & SPRAY VALVE - STAINLESS STEEL COVER



HOSE REEL SWING WALL BRACKETS

ITEM	DESCRIPTION
75199	SWING WALL BRACKET FOR OPEN STAINLESS STEEL CONSTRUCTED HOSE REELS



HOSE REEL PIVOT FLOOR BRACKETS

ITEM	DESCRIPTION
75200	PIVOT FLOOR BRACKET FOR OPEN STAINLESS STEEL CONSTRUCTED HOSE REELS



REEL RINSE CONTROL UNIT

BRASS	DESCRIPTION
1801	REEL RINSE CONTROL UNIT



REEL RINSE EXPOSED PIPING INSTALLATION KIT

BRASS	DESCRIPTION
29475	REEL RINSE EXPOSED PIPING INSTALLATION KIT



REEL RINSE CONCEALED PIPING INSTALLATION KIT

BRASS	DESCRIPTION
28266	REEL RINSE CONCEALED PIPING INSTALLATION KIT



WALL MOUNTED REEL RINSE UNIT INSTALLATION KIT

BRASS	DESCRIPTION
28231	WALL MOUNTED REEL RINSE UNIT INSTALLATION KIT



1/2" ANTI-SPILL VACUUM BREAKER

BRASS	DESCRIPTION
14443	1/2" ANTI-SPILL VACUUM BREAKER

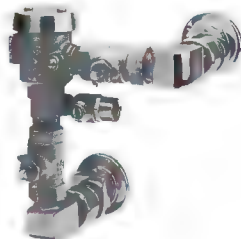

1/2" WALL MOUNT ANTI-SPILL VACUUM BREAKER

BRASS	DESCRIPTION
14540	1/2" WALL MOUNT ANTI-SPILL VACUUM BREAKER



ATMOSPHERIC VACUUM BREAKERS

BRASS	DESCRIPTION
2932-8000	ATMOSPHERIC VACUUM BREAKERS 1/4" FEMALE INLET X 1/4" FEMALE OUTLET
2932-8002	ATMOSPHERIC VACUUM BREAKERS 3/8" FEMALE INLET X 3/8" FEMALE OUTLET
75117	ATMOSPHERIC VACUUM BREAKERS 1/2" FEMALE INLET X 1/2" FEMALE OUTLET



1/2" EXPOSED STOPS

BRASS	DESCRIPTION
2933	1/2" EXPOSED STOP W/ SWIVEL STEM
17639	1/2" EXPOSED STOP W/ CHECK STEM



1/2" CONCEALED STOP

BRASS	DESCRIPTION
13676	1/2" CONCEALED STOP W/ SWIVEL STEM



1/2" CHECK VALVE

BRASS	DESCRIPTION
2936-9000	1/2" CHECK VALVES

REEL RINSE CONTROL BOX

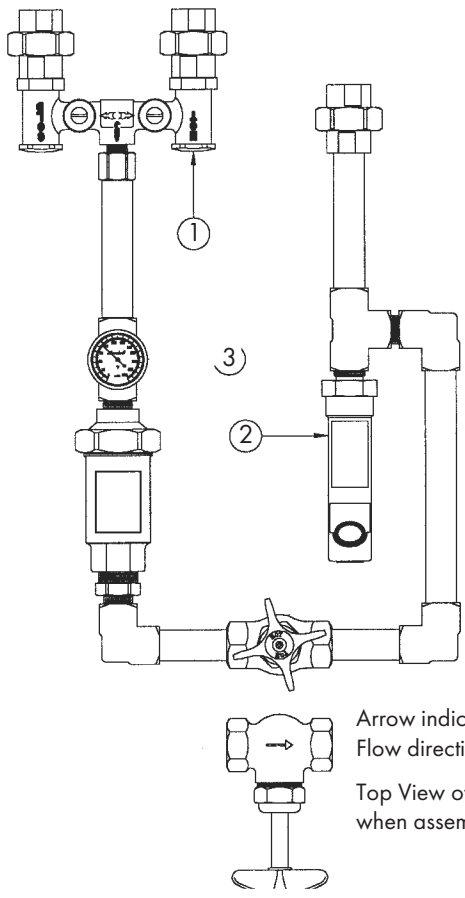
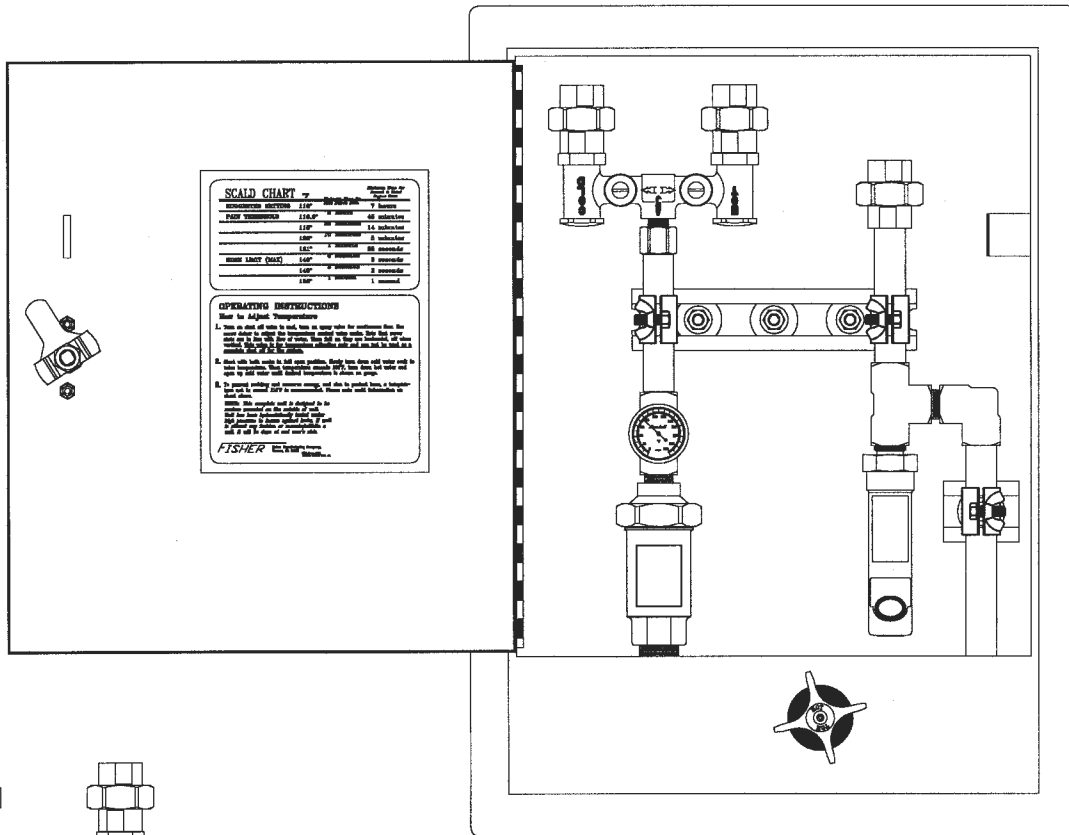

#1801 Consists of:

- ① #2970-3— Temperature Control Valve 1/2"
- ② #2937-9000 — Accessory Water Silencer

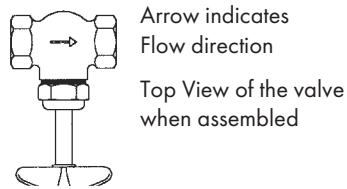

THIS PAGE INTENTIONALLY BLANK

CONCEALED MOUNTING

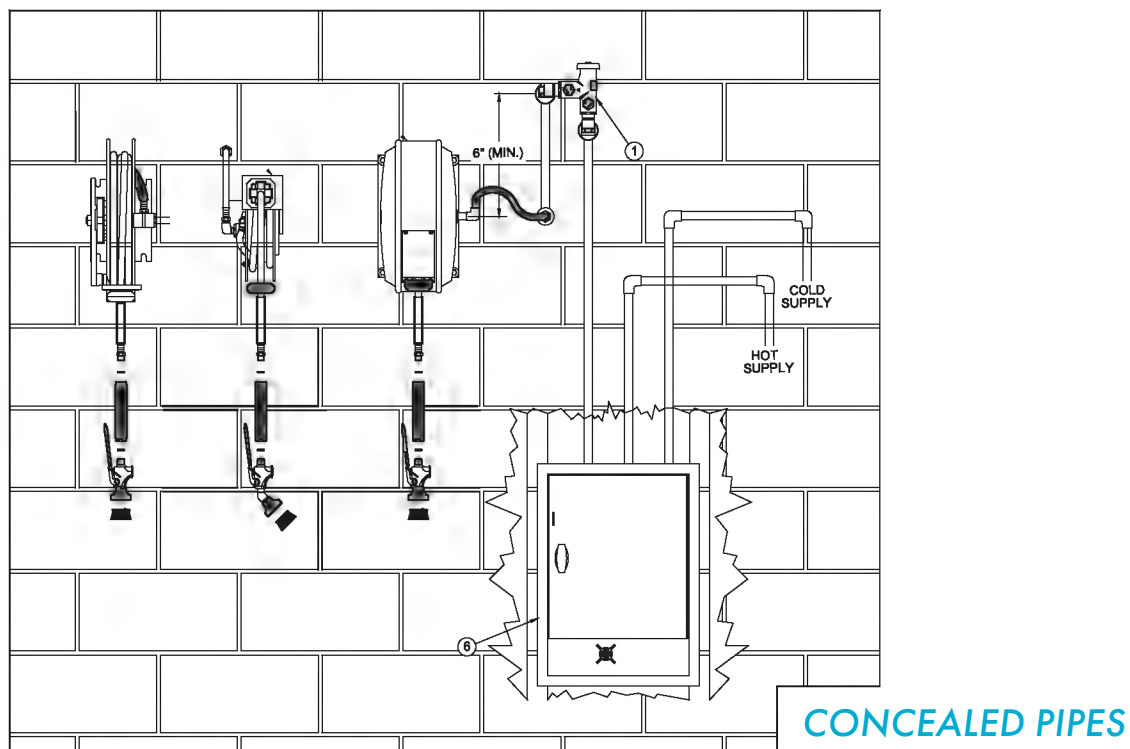

EXPOSED MOUNTING

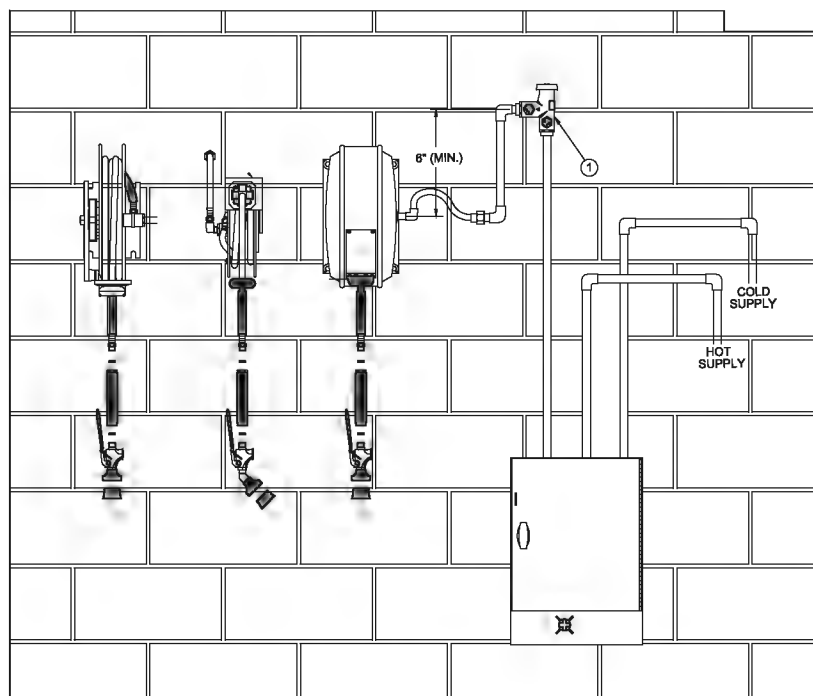

* PIPES ARE NOT SUPPLIED BY FISHER MFG CO.

EXPOSED PIPES

CONCEALED MOUNTING

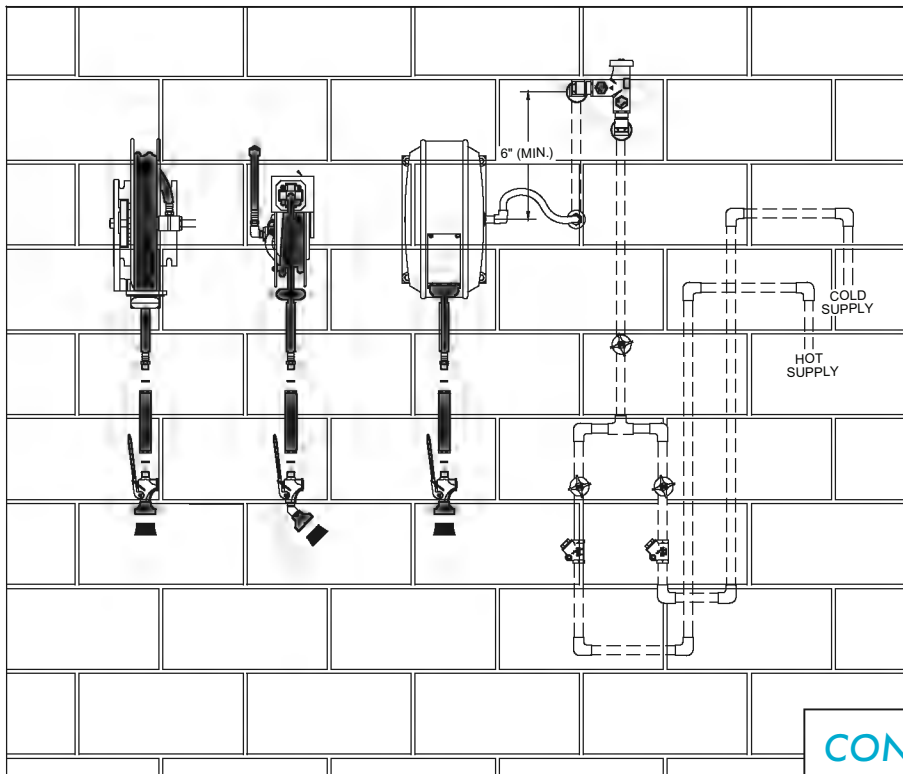

CONCEALED PIPES

EXPOSED MOUNTING

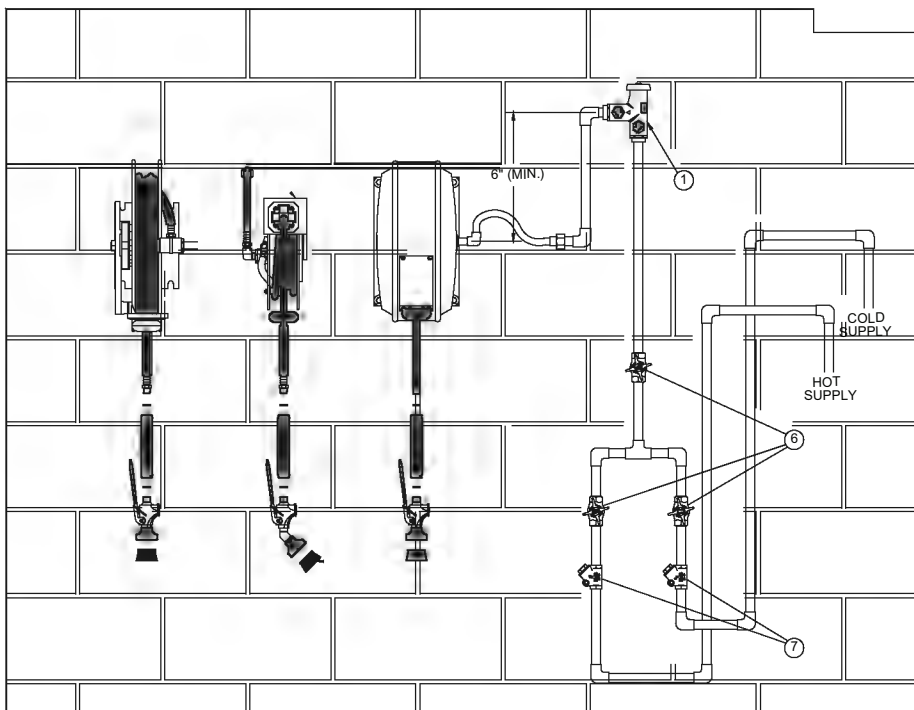

EXPOSED PIPES

* PIPES ARE NOT SUPPLIED BY FISHER MFG CO.

THIS PAGE INTENTIONALLY BLANK

DRAINING™

The next generation of Rotary Waste Valves is here the Draining™ by Fisher! The Draining™ features a revolutionary design engineered to withstand the harsh conditions and chemicals found in today's food services operations. The Draining's value approach to this increasing problem places durable stainless steel only where it's needed to ensure the durability that Fisher products are known for. Over the years Fisher Waste Valves have acquired an outstanding reputation as the forerunner in quality and we know the Draining™ will be no exception!

*Our Draining has a 99 year warranty and 1 year warranty on lever handle.

CHECK OUT THE THESE DRAINING™ FEATURES:

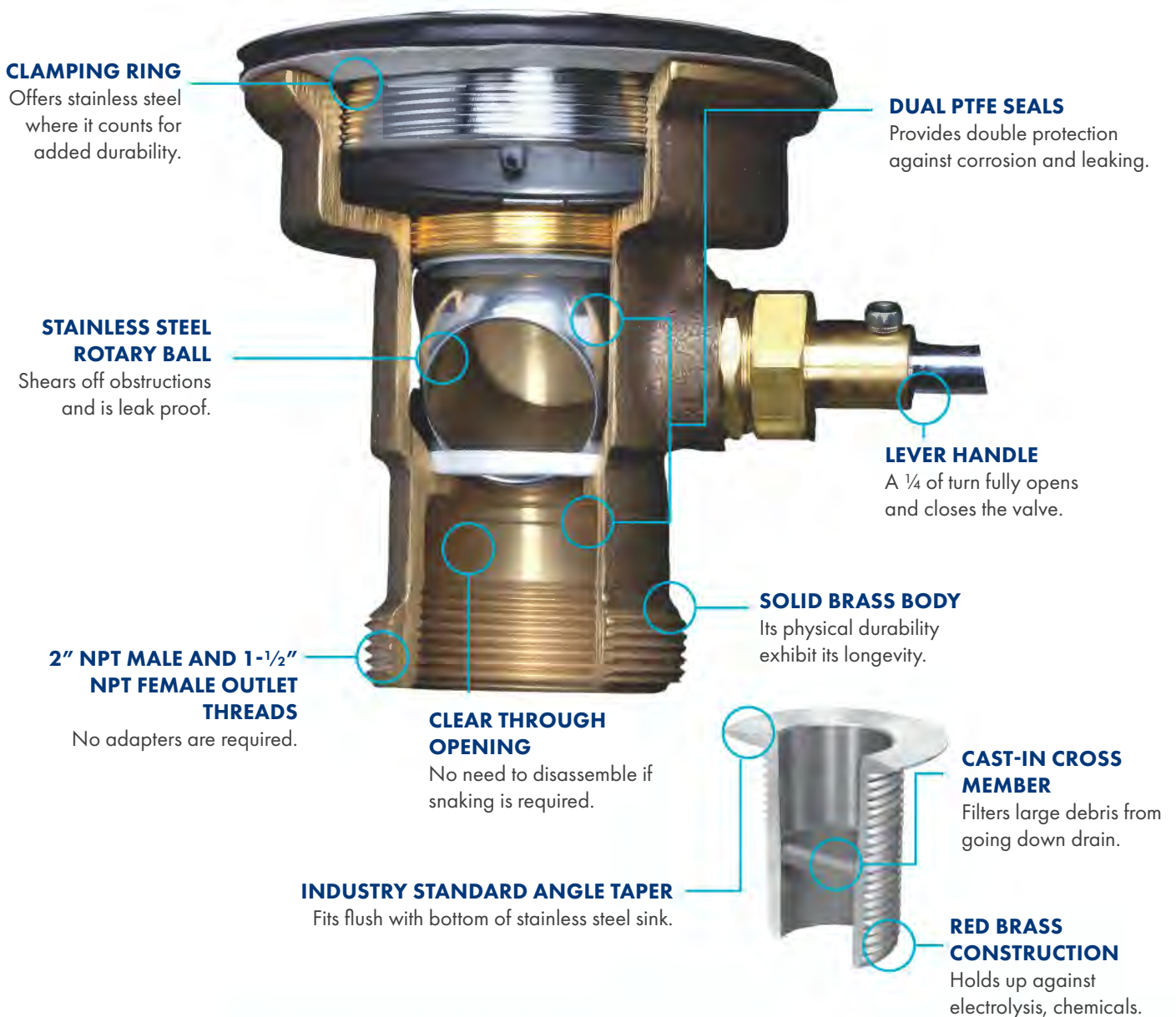



DRAINING W/ FLAT STRAINERS & LEVER HANDLE

ITEM	DESCRIPTION
22209	DRAINING W/ FLAT STRAINER - BRASS FINISH
28932	DRAINING W/ FLAT STRAINER - CHROME FINISH
ACCESSORIES	
6129	2" X 6" LONG TAILPIECE CHROME - FITS DRAININGS AND 2" WASTE SOCKETS



DRAINING W/ FLAT STRAINERS, OVERFLOW ASSEMBLY & LEVER HANDLE

ITEM	DESCRIPTION
22306	DRAINING W/ FLAT STRAINER & 19" X 21" OVERFLOW TUBE & ELBOW - BRASS FINISH
28940	DRAINING W/ FLAT STRAINER & 19" X 21" OVERFLOW TUBE & ELBOW - CHROME FINISH
22322	DRAINING W/ FLAT STRAINER & 14" X 16" OVERFLOW TUBE & ELBOW - BRASS FINISH
28967	DRAINING W/ FLAT STRAINER & 14" X 16" OVERFLOW TUBE & ELBOW - CHROME FINISH
22438	DRAINING W/ FLAT STRAINER WITHOUT OVERFLOW TUBE & ELBOW - BRASS FINISH
29033	DRAINING W/ FLAT STRAINER W/OUT OVERFLOW TUBE & ELBOW - CHROME FINISH
ACCESSORIES	
6129	2" X 6" LONG TAILPIECE CHROME - FITS DRAININGS AND 2" WASTE SOCKETS

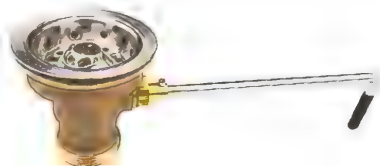

DRAINING W/ LOCKING BASKET STRAINERS & LEVER HANDLE

ITEM	DESCRIPTION
22349	DRAINING W/ LOCKING BASKET STRAINER - BRASS FINISH
28983	DRAINING W/ LOCKING BASKET STRAINER - CHROME FINISH
ACCESSORIES	
6129	2" X 6" LONG TAILPIECE CHROME - FITS DRAININGS AND 2" WASTE SOCKETS



DRAINING W/ LOCKING BASKET STRAINERS, OVERFLOW ASSEMBLY & LEVER HANDLE

ITEM	DESCRIPTION
22314	DRAINING W/ LOCKING BASKET STRAINER & 19" X 21" OVERFLOW TUBE & ELBOW - BRASS FINISH
28959	DRAINING W/ LOCKING BASKET STRAINER & 19" X 21" OVERFLOW TUBE & ELBOW - CHROME FINISH
22330	DRAINING W/ LOCKING BASKET STRAINER & 14" X 16" OVERFLOW TUBE & ELBOW - BRASS FINISH
28975	DRAINING W/ LOCKING BASKET STRAINER & 14" X 16" OVERFLOW TUBE & ELBOW - CHROME FINISH
22411	DRAINING W/ LOCKING BASKET STRAINER WITHOUT OVERFLOW TUBE & ELBOW - BRASS FINISH
29025	DRAINING W/ LOCKING BASKET STRAINER WITHOUT OVERFLOW TUBE & ELBOW - CHROME FINISH
ACCESSORIES	
6129	2" X 6" LONG TAILPIECE CHROME - FITS DRAININGS AND 2" WASTE SOCKETS



SINK DRAIN ASSEMBLY

ITEM	DESCRIPTION
6556	1 1/2" CAST BRASS SINK DRAIN ASSEMBLY W/ BASKET STRAINER
30376	1 1/2" STAINLESS STAMPED SINK DRAIN ASSEMBLY W/ BASKET STRAINER



3/4" WASTE SOCKETS

ITEM	DESCRIPTION
6642-2100	3/4" X 1 3/4" LONG WASTE SOCKET - BRASS
10448	3/4" X 1 3/4" LONG WASTE SOCKET - BRASS CHROME FINISH
ACCESSORIES	
6651-9000	3/4" LOCKNUT - BRASS
1400-5000	3/4" GASKET - NEOPRENE



1" WASTE SOCKETS

ITEM	DESCRIPTION
6240-2100	1" X 2" LONG WASTE SOCKET - BRASS
6440-2100	1" X 4" LONG WASTE SOCKET - BRASS
84085	1" X 2" LONG WASTE SOCKET, LOCKNUT & GASKET - BRASS
84093	1" X 4" LONG WASTE SOCKET, LOCKNUT & GASKET - BRASS
6241-2400	1" X 2" LONG WASTE SOCKET - BRASS CHROME FINISH
6441-2400	1" X 4" LONG WASTE SOCKET - BRASS CHROME FINISH
ACCESSORIES	
6250-2100	1" LOCKNUT - BRASS
6280-5000	1" GASKET - NEOPRENE



1 1/2" WASTE SOCKETS

ITEM	DESCRIPTION
6540-2100	1 1/2" X 1 1/2" LONG WASTE SOCKET - BRASS
6541-2400	1 1/2" X 1 1/2" LONG WASTE SOCKET - BRASS CHROME FINISH
ACCESSORIES	
6550-2100	1 1/2" LOCKNUT - BRASS
6580-5000	1 1/2" GASKET - FIBER
6544-0000	1 1/2" X 4" LONG TAILPIECE BRASS CHROME FINISH - FITS DRAINS AND 1 1/2" WASTE SOCKETS



LOCKNUT

ITEM	DESCRIPTION
6651-9000	¾" LOCKNUT BRASS
6250-2100	1" LOCKNUT BRASS
6550-2100	1-½" LOCKNUT BRASS



GASKETS

ITEM	DESCRIPTION
1400-5000	¾" GASKET - NEOPRENE
6280-5000	1" GASKET - NEOPRENE
6580-5000	1 ½" GASKET - FIBER



TAILPIECE

STAINLESS	DESCRIPTION
6544-0000	1 ½" X 4" LONG TAILPIECE CHROME - FITS DRAINS AND 1 ½" WASTE SOCKETS
6129	2" X 6" LONG TAILPIECE CHROME - FITS DRINKINGS AND 2" WASTE SOCKETS



SOCKET ½" DRIVE 1" HEX

STAINLESS	DESCRIPTION
42757	SOCKET ½" DRIVE 1" HEX

GAS HOSES

Fisher's gas hoses are high quality and are designed to provide reliable and safe gas connections in a variety of settings to meet all your commercial plumbing needs. Ideal for restaurants, hospitals, schools, hotels, grocery/retail. Fisher has a 10 year warranty.

CHECK OUT THESE GAS HOSE FEATURES:

PVC COATED

For sanitation

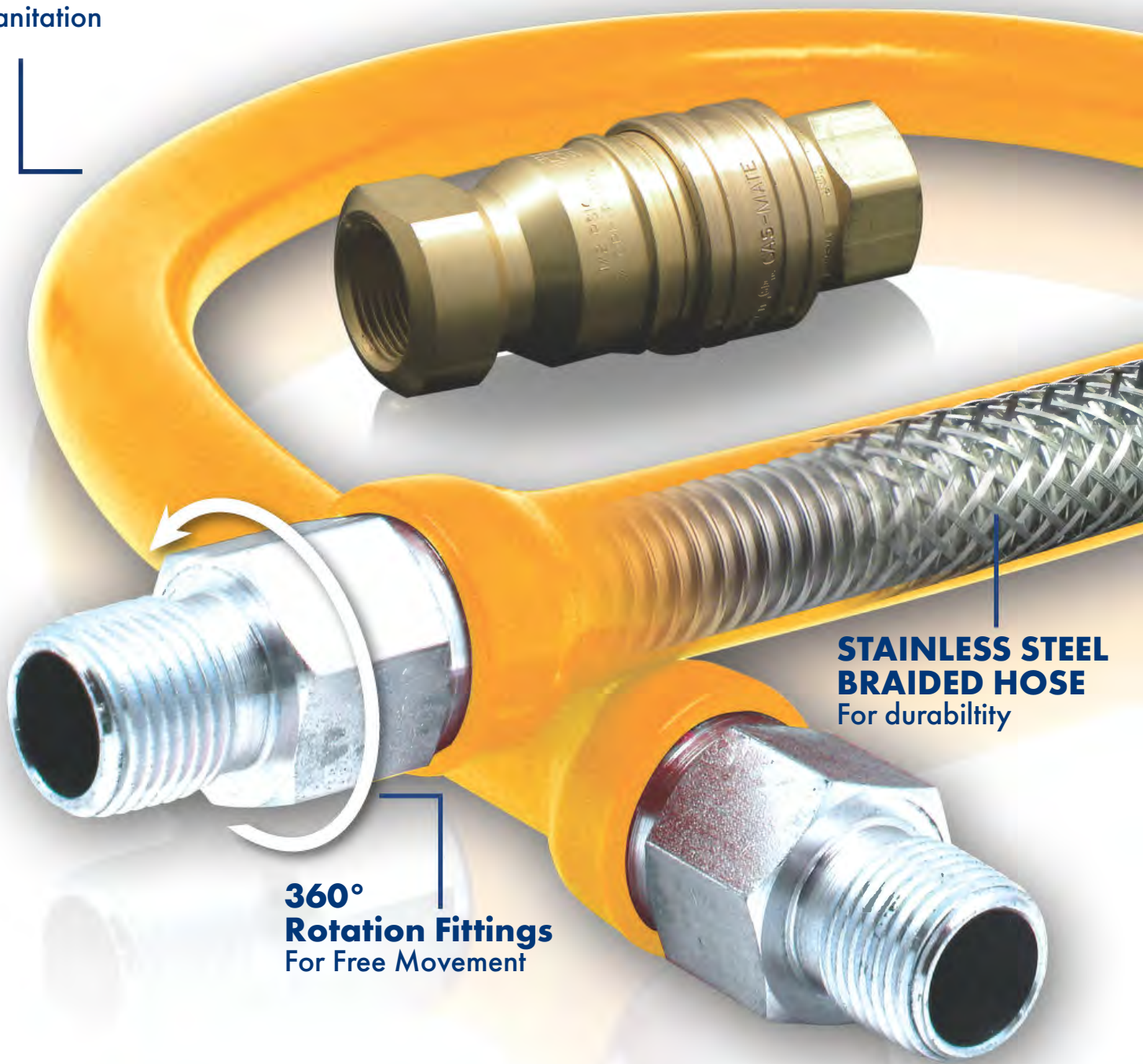

**STAINLESS STEEL
BRAIDED HOSE**
For durability

**360°
Rotation Fittings**
For Free Movement



GAS HOSES

PART	DESCRIPTION
75498	1/2" x 48" ACCESSORIES INCLUDED
75497	3/4" x 36" ACCESSORIES INCLUDED
75496	3/4" x 48" ACCESSORIES INCLUDED
75499	1" x 48" ACCESSORIES INCLUDED



GAS HOSE SWIVEL

PART	DESCRIPTION
75979	GAS HOSE 3/4" SWIVEL
75980	GAS HOSE 1" SWIVEL

THIS PAGE INTENTIONALLY BLANK



4" REMOTE CONTROL VALVE

BRASS LEVER HANDLES	DESCRIPTION
2805	4" REMOTE CONTROL VALVE W/ SWIVEL STEMS
2805-CV	4" REMOTE CONTROL VALVE W/ CHECK STEMS



1/2" EXPOSED STOPS

BRASS CROSS HANDLES	DESCRIPTION
2933	1/2" EXPOSED STOP W/ SWIVEL STEM
17639	1/2" EXPOSED STOP W/ CHECK STEM



1/2" CONCEALED STOP

BRASS CROSS HANDLES	DESCRIPTION
13676	1/2" CONCEALED STOP W/ SWIVEL STEM

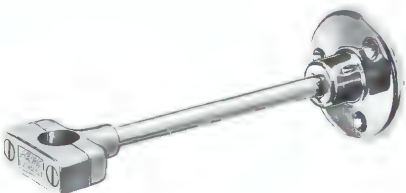

WALL BRACKET

ITEM	DESCRIPTION
2902-12	WALL BRACKET



PRE-RINSE & FOODGRADE HOSES

PRE-RINSE	FOODGRADE	DESCRIPTION
2916-1512	12297	15" HOSE
12130	12319	21" HOSE
2916-2512	12327	25-1/2" HOSE
12157	12343	30" HOSE
2914	2914-FG	36" HOSE
12165	12351	42" HOSE
12173	12378	48" HOSE
2915	2915-FG	60" HOSE
12203	12394	72" HOSE
12211	12408	84" HOSE
12238	12416	96" HOSE
12254	12432	120" HOSE



REPLACEMENT PRE-RINSE HOSES

BRASS	DESCRIPTION
2918	36" LENGTH HOSE, HANDLE & ADAPTER OVERALL LENGTH 44" (FITS FISHER & T&S)
2918-68	60" LENGTH HOSE, HANDLE & ADAPTER OVERALL LENGTH 68" (FITS FISHER & T&S)



REPLACEMENT PRE-RINSE HOSE W/ ULTRA SPRAY VALVE

BRASS	DESCRIPTION
2911	36" HOSE, HANDLE & ULTRA SPRAY VALVE (FITS FISHER ONLY)



GOOSENECK SPRING

BRASS	STAINLESS STEEL	DESCRIPTION
2924-6000	74661	GOOSENECK SPRING



ADD ON FAUCETS FOR PRE-RINSE UNITS

BRASS LEVER HANDLES	DESCRIPTION
2901-0000	ADD-ON FAUCET W/ 4" RISER LESS SPOUT
2901	ADD-ON FAUCET W/ 4" RISER W/ 6" SPOUT
2901-12	ADD-ON FAUCET W/ 4" RISER W/ 12" SPOUT



ADD ON FAUCET FOR PRE-RINSE UNITS CERAMIC

BRASS CERAMIC LEVER HANDLES	DESCRIPTION
29010	ADD-ON FAUCET W/ 4" RISER LESS SPOUT
29060	ADD-ON FAUCET W/ 4" RISER W/ 6" SPOUT
29120	ADD-ON FAUCET W/ 4" RISER W/ 12" SPOUT



3/4" ADD-ON FAUCETS FOR PRE-RINSE UNITS

BRASS CROSS HANDLES	DESCRIPTION
21482	ADD-ON FAUCET W/ 4" RISER LESS SPOUT



RISERS FOR PRE-RINSE UNITS

BRASS	DESCRIPTION
72747	2" RISER
72748	4" RISER
2927-4302	12" RISER
2927-4303	16" RISER
2927-4300	21" RISER
72749	25" RISER
72750	31" RISER



PRE-RINSE AND REEL RINSE INSULATED HANDLES

BRASS	STAINLESS STEEL	DESCRIPTION
2913	71390	PRE-RINSE INSULATED HANDLES 3/4"-14 FEMALE X 3/4"-14 FEMALE
2913-38	N/A	REEL RINSE INSULATED HANDLE 3/4"-14 FEMALE X 3/8" NPT FEMALE



HOSE HOOK FOR SPRING PRE-RINSE UNITS

BRASS	DESCRIPTION
2925-6300	HOSE HOOK FOR SPRING PRE-RINSE UNITS



SWIVEL ADAPTER FOR SWIVEL HOSE UNITS

BRASS	DESCRIPTION
2931	SWIVEL ADAPTER FOR 1/2" SWIVEL HOSE UNITS, 1/4" FEMALE OUTLET



SWIVEL VACUUM BREAKER ADAPTER FOR SWIVEL HOSE UNITS

BRASS	DESCRIPTION
2932	SWIVEL VACUUM BREAKER ADAPTER FOR 1/2" SWIVEL HOSE UNITS, 1/4" FEMALE OUTLET
10480	SWIVEL VACUUM BREAKER ADAPTER FOR 3/4" SWIVEL HOSE UNITS, 3/4" FEMALE OUTLET



TEMPERATURE CONTROL VALVE

BRASS	DESCRIPTION
2970-3	TEMPERATURE CONTROL VALVE 1/2" MALE INLETS X 1/2" FEMALE SLIP JOINT OUTLET W/ CHECK VALVES



3/4" CONTROL SWING SPOUT

BRASS	DESCRIPTION
5071	3/4" CONTROL SWING SPOUT



WALL HOOK

ITEM	DESCRIPTION
2907	WALL HOOK



PIPE HOOK

ITEM	DESCRIPTION
2943	PIPE HOOK



3/4" SWIVEL ADAPTER VACUUM BREAKER

BRASS	DESCRIPTION
10480	3/4" SWIVEL ADAPTER FOR 3/4" POT FILLER HOSE ASSEMBLY

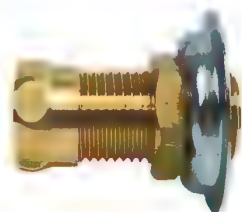

NIPPLES FOR WALL FAUCETS

BRASS	STAINLESS STEEL	DESCRIPTION
2200-0000	71439	NIPPLE FOR 1/2" WALL FAUCETS 1/2" NPT MALE X 1/2" NPT MALE X 1 3/4" LONG W/ SLIP JOINT KIT
10219	70645	NIPPLE FOR 3/4" WALL FAUCETS 3/4" NPT MALE X 3/4" NPT MALE X 1 1/4" LONG W/ SLIP JOINT KIT



ELBOWS FOR WALL FAUCETS

BRASS	STAINLESS STEEL	DESCRIPTION
2400-2103	N/A	ELBOWS FOR 1/2" WALL FAUCETS 1/2" NPT FEMALE X 1/2" NPT FEMALE
5000-2103	N/A	ELBOWS FOR 3/4" WALL FAUCETS 3/4" NPT FEMALE X 3/4" NPT FEMALE
N/A	71498	ELBOW FOR 1/2" WALL W/ NIPPLES & BACKSPASH PRE-RINSES 1/2" NPT F X 1/2" NPT F
N/A	71447	ELBOWS FOR 1/2" WALL W/ NIPPLES & BACKSPASH PRE-RINSES 1/2" NPT F X 1/2" NPT F (2 EACH)



SUPPLY LINES

BRASS	DESCRIPTION
10022	SUPPLY LINE 1/2" FEMALE X 1/2" FEMALE X 36" LONG
10006	SUPPLY LINE 1/2" FEMALE X 1/2" MALE X 36" LONG



1/2" SWIVEL DOUBLE JOINT

BRASS	STAINLESS STEEL	DESCRIPTION
3000-0003	54461	7-1/4" SWIVEL DOUBLE JOINT
4000-0002	55050	13" SWIVEL DOUBLE JOINT

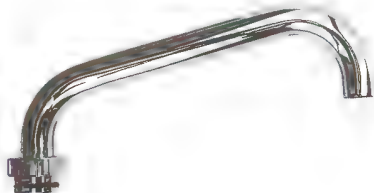

3/4" SPOUTS

BRASS	DESCRIPTION
5000-0001	10" SWIVEL SPOUT
5000-0002	14" SWIVEL SPOUT



1/2" CONTROL SWING SPOUT

BRASS	DESCRIPTION
40000	1/2" CONTROL SWING SPOUT



3/4" SWIVEL DOUBLE JOINT

BRASS	STAINLESS STEEL	DESCRIPTION
5000-0003	54259	10" SWIVEL DOUBLE JOINT



ULTRA SPRAY VALVE

BRASS	STAINLESS STEEL	DESCRIPTION
2949	71307	ULTRA SPRAY VALVE PLUS 1.15 GPM KNIFE EDGE SPRAY PATTERN
13641	10197	ULTRA SPRAY VALVE 7 PLUS .70 GPM KNIFE EDGE SPRAY PATTERN



UTILITY SPRAY VALVE

BRASS	DESCRIPTION
2920	UTILITY VALVE 2.15 GPM SHOWER HEAD SPRAY PATTERN



POT FILLER VALVE

BRASS	DESCRIPTION
11061	POT FILLER VALVE FULL FLOW NEOSTRAL SPOUT END



GLASS FILLER VALVE

BRASS	DESCRIPTION
10820	GLASS FILLER VALVE



JET SPRAY VALVE

BRASS	DESCRIPTION
10863	JET VALVE PLUS 2.45 GPM SINGLE STREAM JET SPRAY PATTERN



UTILITY SPRAY VALVE W/ SHORT SQUEEZE LEVER

BRASS	DESCRIPTION
10073	UTILITY VALVE W/ SHORT SQUEEZE LEVER 2.15 GPM SHOWER HEAD SPRAY PATTERN



GLASS RACK GLASS FILLER VALVE

BRASS	DESCRIPTION
1704	GLASS FILLER VALVE W/ SHORT SQUEEZE LEVER



GLASS RACK GLASS FILLER VALVE

BRASS	DESCRIPTION
10812	GLASS RACK GLASS FILLER VALVE



QUICK DISCONNECT MULTI PURPOSE VALVE

BRASS	DESCRIPTION
29500	QUICK DISCONNECT MULTI PURPOSE VALVE W/ SHOWER SPRAY, FAN SPRAY, JET SPRAY & POT FILLER



SPRAY HEAD

BRASS	DESCRIPTION
2923	SPRAY HEAD W/ HANDLE 2.15 GPM SHOWER HEAD SPRAY PATTERN, 3/8" NPT FEMALE INLET

THIS PAGE INTENTIONALLY BLANK

PRICE LIST

PRICES EFFECTIVE
JANUARY 1, 2024

ITEM #	ITEM DESCRIPTION	PRICE
1007	GLASS FILLER 08PED 3/8M	\$202.00
1008	GLASS FILLER 10PED 3/8M	\$200.00
10090	GLASS FILLER 08PED 06SS	\$360.00
1400	GLASS STATION 10PED	\$392.00
1465	GLASS FILLER HAS 60	\$291.00
1704	GLASS FILLER VALVE SHORT LEVER	\$151.00
1731	FAUCET SDLH LAV PCA SPRAY 0.35 GPM	\$168.00
1744	FAUCET 4DLH LAV PCA SPRAY 0.35 GPM	\$470.00
1791	HOSE PR W/O SS 60	\$119.00
1798	ECCENTRIC STOP KIT SS 1/2F	\$156.00
1801	REEL RINSE CONTROL UNIT	\$3,228.00
1802	STOP EXPXH SV RIGHT HAND LONG	\$113.00
1803	DUAL CHECK VALVE 1/2F X 1/2F	\$303.00
2267	3/4 FAUCET 8AWLH 10CS10DJ	\$1,123.00
2275	3/4 FAUCET 8DLH 10CS10DJ	\$921.00
2283	3/4 FAUCET 8BSELH 10CS10DJ	\$1,049.00
2542	DUAL CHECK VACUUM BREAKER 1/4F X 1/4M CR	\$275.00
2805	CONTROL VALVE 4RLH SV	\$274.00
2903	BASE DECK RIG	\$54.00
2905	TROUGH FITTING ASSY	\$69.00
2907	WALL HOOK	\$54.00
2911	ULTRA SPRAY HAL 36	\$273.00
2913	HANDLE 3/4-14F X 3/4-14F	\$36.00
2914	HOSE PR 36	\$91.00
2915	HOSE PR 60	\$131.00
2918	HOSE PR ASSY T&S 44	\$118.00
2920	UTILITY VALVE LONG LEVER	\$164.00
2922	ADPTR 1/4F X 3/4-14F	\$19.00
2923	SPRAY HEAD 3/8 2.15 GPM	\$56.00
2928	PR-ERINSE SPG 21R	\$426.00
2931	SWIVEL ELBOW 1/4	\$69.00
2932	SWIVEL VACUUM BREAKER 1/4	\$167.00
2933	STOP EXPXH SV RIGHT HAND	\$119.00
2943	PIPE HOOK	\$50.00
2948	HANDLE SPRAY 3/4-14	\$93.00
2949	ULTRA SPRAY VALVE PLUS	\$117.00
2976	VANDAL RESISTANT KIT	\$88.00
2990	PRO SPRAY	\$123.00
3041	FAUCET DIPPERWELL SINK	\$342.00
3042	FAUCET DIPPERWELL	\$151.00
3043	BOWL DIPPERWELL ASSY	\$170.00
3069	COUPLING 3/4-14 POL CR	\$31.00
3070	SGL FLOOR FOOT VALVE	\$226.00
3074	SGL KNEE VALVE	\$226.00

ITEM #	ITEM DESCRIPTION	PRICE
3076	SGL WALL FOOT VALVE	\$265.00
3170	DUAL FLOOR FOOT VALVE	\$368.00
3174	DUAL KNEE VALVE	\$368.00
3176	DUAL WALL FOOT VALVE	\$396.00
3800	BASE DECK SVL	\$60.00
3815	FAUCET BD 12SGN 2.20 GPM	\$124.00
3816	FAUCET BD 12RGN PER 2.20 GPM	\$105.00
3900	BASE BACKSPLASH SVL	\$76.00
3915	FAUCET BBS 12SGN 2.20 GPM	\$150.00
3916	FAUCET BBS 12RGN PER 2.20 GPM	\$125.00
3960	SPOUT 06SS PER 2.20 GPM	\$49.00
3961	SPOUT 08SS PER 2.20 GPM	\$47.00
3962	SPOUT 10SS PER 2.20 GPM	\$49.00
3963	SPOUT 12SS FULL FLOW LAMINAR	\$50.00
3964	SPOUT 14SS PER 2.20 GPM	\$55.00
3965	SPOUT 12SGN 2.20 GPM	\$61.00
3966	SPOUT 12RGN 2.20 GPM	\$50.00
3967	SPOUT 16SS PER 2.20 GPM	\$56.00
3968	SPOUT 06SGN 2.20 GPM	\$54.00
3969	SPOUT 06RGN PER 2.20 GPM	\$45.00
3983	HANDLE KIT CROSS	\$19.00
3984	HANDLE KIT WRIST	\$54.00
3990	VACUUM BREAKER ATMOSPHERE LEDGE 1/2	\$392.00
3991	VACUUM BREAKER ATMOSPHERE DECK 1/2	\$349.00
5000	3/4 CONTROL VALVE SDXH SVL SV	\$338.00
5008	3/4 POT FILLER SVB 12SGN 72HO	\$953.00
5012	3/4 FAUCET SDXH 10SS	\$454.00
5014	3/4 FAUCET SDXH 14SS	\$466.00
5030	3/4 FAUCET SDXH 10CS10DJ	\$851.00
5040	3/4 POT FILLER SVB SDXH SGN	\$1,259.00
5071	3/4 SPOUT 10CS	\$326.00
5200	3/4 CONTROL VALVE 8AWLH SVL SV	\$654.00
5212	3/4 FAUCET 8AWLH 10SS	\$808.00
5214	3/4 FAUCET 8AWLH 14SS	\$814.00
5240	3/4 POT FILLER SVB 8AWLH SGN	\$1,747.00
5300	3/4 CONTROL VALVE 8DLH SVL SV	\$461.00
5312	3/4 FAUCET 8DLH 10SS	\$544.00
5314	3/4 FAUCET 8DLH 14SS	\$548.00
5340	3/4 POT FILLER SVB 8DLH SGN	\$1,446.00
5400	3/4 CONTROL VALVE 8BSELH SVL SV	\$611.00
5412	3/4 FAUCET 8BSELH 10SS	\$825.00
5414	3/4 FAUCET 8BSELH 14SS	\$833.00
5440	3/4 POT FILLER SVB 8BSELH SGN	\$1,757.00
5700	3/4 CONTROL VALVE SWXH SVL SV	\$291.00

ITEM #	ITEM DESCRIPTION	PRICE
5712	¾ FAUCET SWXH 10SS	\$396.00
5714	¾ FAUCET SWXH 14SS	\$408.00
5730	¾ FAUCET SWXH 10CS10DJ	\$792.00
5740	¾ POT FILLER SVB SWXH SGN	\$1,259.00
6129	TAILPIECE 2 X 6 CR	\$65.00
6343	FITTING THRU DECK	\$61.00
6556	DRAIN BASKET STRAINER BRS POL CR 3 ½	\$78.00
9033	GLASS FILLER HEAD FLARE	\$146.00
9131	FAUCET BBS 06RGN PER 2.20 GPM	\$119.00
10006	SUPPLY LINE ½F X ½M X 36	\$54.00
10022	SUPPLY LINE ½F X ½F X 36	\$50.00
10073	UTILITY VALVE SHORT LEVER	\$151.00
10197	SS ULTRA SPRAY VALVE 7 PLUS	\$200.00
10200	GLASS FILLER HEAD 3/8F	\$163.00
10219	CLOSE NIPPLE ¾	\$41.00
10448	WASTE SOCKET ¾ X 1 ¾ BRS CR	\$38.00
10480	ADPTR SVL VB ¾	\$272.00
10812	BANQUET FILLER VALVE	\$122.00
10820	GLASS FILLER VALVE LONG LEVER	\$151.00
10863	JET VALVE	\$123.00
11061	POT FILLER VALVE LONG LEVER	\$161.00
11150	GASKET FIBER	\$5.00
11170	BANQUET SPG SDCDLH	\$539.00
11177	NUT HEX M4 X 7MM	\$3.00
11185	SCREW SOCKET M4 X 25MM	\$3.10
11223	OVERFLOW ELBOW DRAINING	\$67.00
11231	STRAINER FLAT SS	\$11.00
11258	STRAINER BASKET SS	\$19.00
11274	GASKET CLAMPING RING	\$5.00
11282	REPAIR KIT PR-ERINSE & FAUCET	\$151.00
11347	REPAIR KIT GLASS FILLER BRS	\$44.00
11355	REPAIR KIT SPRAY VALVE BRS	\$61.00
11770	UTILITY SPRAY SVEI 8AWCDLH 14SS	\$1,069.00
12122	HOSE PR 18	\$77.00
12130	HOSE PR 21	\$79.00
12157	HOSE PR 30	\$84.00
12165	HOSE PR 42	\$99.00
12173	HOSE PR 48	\$111.00
12203	HOSE PR 72	\$150.00
12211	HOSE PR 84	\$155.00
12238	HOSE PR 96	\$188.00
12254	HOSE PR 120	\$222.00
12297	HOSE FG 15	\$74.00
12319	HOSE FG 21	\$79.00

ITEM #	ITEM DESCRIPTION	PRICE
12327	HOSE FG 25 ½	\$82.00
12343	HOSE FG 30	\$87.00
12351	HOSE FG 42	\$97.00
12378	HOSE FG 48	\$102.00
12394	HOSE FG 72	\$125.00
12408	HOSE FG 84	\$147.00
12416	HOSE FG 96	\$156.00
12432	HOSE FG 120	\$187.00
12475	ADPTR 3/8F X T&S SVLF 304 POL	\$37.00
12491	CYLINDER KIT FOOT VALVE SS	\$47.00
12513	GLASS FILLER 12PED 3/8M	\$216.00
12564	AERATOR 55/64-27F PER 2.20 GPM	\$7.00
12726	GLASS FILLER 14PED 3/8M	\$236.00
12769	COUPLING 3/8 NL BRS POL CR	\$32.00
12810	CTL VLV SDCDLH SVL SV	\$149.00
13150	CTL VLV 8BSCDLH SVL SV	\$256.00
13210	FAUCET 8BSCDLH 16SS	\$306.00
13220	FAUCET 8BSCDLH 06SGN 2.20 GPM	\$317.00
13230	FAUCET 8BSCDLH 06SS	\$296.00
13240	FAUCET 8BSCDLH 08SS	\$310.00
13260	FAUCET 8BSCDLH 12SS	\$307.00
13270	FAUCET 8BSCDLH 14SS	\$315.00
13280	FAUCET 8BSCDLH 12SGN 2.20 GPM	\$318.00
13290	FAUCET 8BSCDLH 10SS	\$306.00
13330	PR-ERINSE SPG 8BCDSLH	\$667.00
13380	PR-ERINSE SPG 8BSCDLH INTERNATIONAL SALES ONLY	\$646.00
13641	ULTRA SPRAY VALVE 7 PLUS	\$123.00
13676	STOP CONXH SV RIGHT HAND	\$185.00
13714	ADPTR ¼F X ½F 304	\$25.00
13811	SCREW SHEET METAL 10 X 1 ½ PH OVAL	\$3.00
14443	VACUUM BREAKER PRESSURE ANTISPILL ½	\$1,296.00
14540	VACUUM BREAKER PRESSURE ANTISPILL WALL ½	\$1,290.00
15010	CTL VLV CHCDLH SVL SV	\$187.00
17639	STOP EXPXH CK RIGHT HAND	\$119.00
17901	STOP ANGXH	\$100.00
18210	FAUCET 8DCDLH 06SGN 2.20 GPM	\$384.00
18325	EYEWASH VALVE 3/8M	\$134.00
18560	FAUCET SDCDLH 06SGN 2.20 GPM	\$200.00
18627	ULTRA SPRAY PLUS SS NOZZLE INTL	\$145.00
18720	FAUCET SDDCDLH 06SGN 2.20 GPM	\$291.00
18783	SS STEM ¾ CHECK LH STD KIT	\$69.00
18791	SS STEM ¾ CHECK RH STD KIT	\$69.00
18821	SS STEM ½ SWIVEL LH STD ASSY	\$31.00
18848	SS STEM ½ SWIVEL RH STD ASSY	\$31.00

ITEM #	ITEM DESCRIPTION	PRICE
18856	SS STEM 3/4 SWIVEL LH STD ASSY	\$37.00
18872	SS STEM 3/4 SWIVEL RH STD ASSY	\$37.00
18937	CLAMPING RING DRINKING	\$19.00
19119	O-RING 1/2 SPOUT KIT	\$6.00
19790	FAUCET 8AWCDLH 06SRV	\$422.00
19820	FAUCET 8AWCDZLH 03SRV	\$388.00
19960	FAUCET 4BSCDLH 06SGN 2.20 GPM	\$329.00
20020	SNAP RING FERRULE 1/2	\$3.00
20100	PR-ERINSE SPG SDCDTLH	\$660.00
20168	BALL DRINKING 304 POL	\$37.00
20230	NUT RETAINER DRINKING BRS	\$19.00
20460	FAUCET SWCDLH 06SGN 2.20 GPM	\$164.00
21100	PR-ERINSE SPG SDDCDLH	\$622.00
21110	PR-ERINSE SPG SDDCDLH INTERNATIONAL SALES ONLY	\$622.00
21229	SEAL TFE	\$11.00
21393	NUT DRINKING ROTOR BRS	\$7.00
21482	3/4 CONTROL VALVE ADDONXH RIG SV	\$547.00
21881	FITTING THRU DECK BROACHED BRS POL CR	\$56.00
22004	REPAIR KIT AVB 1/2	\$130.00
22012	REPAIR KIT AVB 3/4	\$91.00
22100	PR-ERINSE SPG 8AWCDLH	\$667.00
22110	PR-ERINSE SPG 8AWCDLH INTERNATIONAL SALES ONLY	\$680.00
22209	DRAINING FLAT STRAINER BRS	\$239.00
22233	WASTE VLV KEY BRS KIT	\$11.00
22241	ROTOR STOP BRS	\$6.00
22284	SCREW MACHINE 10-32 X 3/4 PIN IN HEX	\$5.00
22292	LOCKING BASKET STRAINER	\$19.00
22306	DRAINING FLAT STRAINER BRS OVF 19 X 21	\$380.00
22314	DRAINING BASKET STRAINER BRS OVF 19 X 21	\$380.00
22322	DRAINING FLAT STRAINER BRS OVF 14 X 16	\$380.00
22330	DRAINING BASKET STRAINER BRS OVF 14 X 16	\$380.00
22349	DRAINING BASKET STRAINER BRS	\$239.00
22365	DRAINING FLAT STRAINER VR BRS	\$338.00
22400	POT FILLER SVB 8AWCDLH	\$766.00
22411	DRAINING BASKET STRAINER BRS OVF	\$255.00
22438	DRAINING FLAT STRAINER BRS OVF	\$255.00
22446	DRAINING FLAT STRAINER VR BRS OVF	\$349.00
22500	POT FILLER SVE 8AWCDLH	\$763.00
22535	DRAINING FLAT STRAINER	\$11.00
22594	CONCENTRIC KIT BRS 1/2M	\$31.00
22780	SPANNER WRENCH BALL	\$117.00
23100	PR-ERINSE SPG 8DCDLH	\$715.00
23110	PR-ERINSE SPG 8DCDLH INTERNATIONAL SALES ONLY	\$974.00
23329	PR-ERINSE SPG 00R INTL	\$338.00

ITEM #	ITEM DESCRIPTION	PRICE
23590	VANDAL RESISTANT KIT WASTE VALVE	\$31.00
23630	PR-ERINSE SPG 8DCDLH 21R INTERNATIONAL SALES ONLY	\$737.00
23698	SS CONTROL VALVE 8AWLH SVL CK	\$360.00
23949	TUBE OVERFLOW 14 X 18 NL BRS CR	\$67.00
24082	TWIST WASTE 1 1/2 FLAT STRAINER CR	\$151.00
24090	TWIST WASTE 2 FLAT STRAINER CR	\$151.00
24104	TWIST WASTE 1 1/2 FLAT STRAINER CR OVF	\$164.00
24112	TWIST WASTE 2 FLAT STRAINER CR OVF	\$159.00
24450	FAUCET 8AWCDLH 03SRV	\$369.00
24848	TWIST WASTE 1 1/2 BASKET STRAINER CR	\$151.00
24856	TWIST WASTE 2 BASKET STRAINER CR	\$149.00
24864	TWIST WASTE 1 1/2 BASKET STRAINER CR OVF	\$153.00
24872	TWIST WASTE 1 1/2 FLAT STRAINER CR OVF 14 X 18	\$253.00
24880	TWIST WASTE 1 1/2 BASKET STRAINER CR OVF 14 X 18	\$251.00
24899	TWIST WASTE 2 BASKET STRAINER CR OVF	\$169.00
24902	TWIST WASTE 2 FLAT STRAINER CR OVF 14 X 18	\$253.00
24910	TWIST WASTE 2 BASKET STRAINER CR OVF 14 X 18	\$254.00
25100	PR-ERINSE SPG 4DCDLH	\$666.00
25110	PR-ERINSE SPG 4DCDLH INTERNATIONAL SALES ONLY	\$646.00
26115	FAUCET WB 8DLH 08SS	\$245.00
26123	FAUCET WB 8DLH 10SS	\$268.00
26131	FAUCET WB 8DLH 12SS	\$270.00
26174	FAUCET WB 4DLH 06SS	\$238.00
26190	FAUCET WB 4DLH 10SS	\$222.00
26298	FAUCET WB 4BSLH 06SGN 2.20 GPM	\$255.00
27100	PR-ERINSE SPG SWCDLH	\$516.00
27400	POT FILLER SVB SWCDLH	\$629.00
27500	POT FILLER SVE SWCDLH	\$535.00
28231	REEL RINSE INSTALL KIT 8AWLH	\$2,205.00
28266	REEL RINSE INSTALL KIT CON	\$2,184.00
28932	DRAINING FLAT STRAINER CR	\$307.00
28940	DRAINING FLAT STRAINER CR OVF 19 X 21	\$408.00
28959	DRAINING BASKET STRAINER CR OVF 19 X 21	\$408.00
28967	DRAINING FLAT STRAINER CR OVF 14 X 16	\$408.00
28975	DRAINING BASKET STRAINER CR OVF 14 X 16	\$408.00
28983	DRAINING BASKET STRAINER CR	\$282.00
29000	CTL VLV ADDONCDLH RIG SV 2	\$109.00
29010	CTL VLV ADDONCDLH RIG SV 4	\$117.00
29025	DRAINING BASKET STRAINER CR OVF	\$302.00
29033	DRAINING FLAT STRAINER CR OVF	\$329.00
29080	FAUCET ADDONCDLH 08SS	\$152.00
29100	FAUCET ADDONCDLH 10SS	\$166.00
29120	FAUCET ADDONCDLH 12SS	\$167.00
29140	FAUCET ADDONCDLH 14SS	\$168.00

ITEM #	ITEM DESCRIPTION	PRICE
29149	END CAP OVERFLOW BRS CR	\$19.00
29160	FAUCET ADDONCDLH 16SS	\$168.00
29203	EZ INSTALL KIT SS T&S	\$29.00
29281	PR-ERINSE 21R INTL	\$403.00
29475	REEL RINSE INSTALL KIT EXP	\$1,983.00
29500	QUICK DISCONNECT VALVE	\$890.00
29521	FAUCET SBS SCRUB 12RGN SHOWERHEAD	\$234.00
29550	FAUCET SWCDLH 03SRV	\$234.00
29662	REEL RINSE WHITE EXP UC 20 FT SV	\$1,085.00
29801	REEL RINSE WHITE EXP WALL 30 FT SV	\$1,926.00
29841	REEL RINSE WHITE EXP UC 20 FT US	\$1,081.00
29851	REEL RINSE WHITE CVD WALL 30 FT SV	\$2,219.00
30100	FAUCET SDCDLH 06SS	\$199.00
30110	FAUCET SDCDLH 08SS	\$201.00
30120	FAUCET SDCDLH 10SS	\$207.00
30130	FAUCET SDCDLH 12SS	\$192.00
30150	FAUCET SDCDLH 12SGN 2.20 GPM	\$204.00
30376	SS DRAIN BASKET STRAINER 3 1/2	\$25.00
31100	FAUCET SDDCDLH 06SS	\$287.00
31130	FAUCET SDDCDLH 12SS	\$307.00
31150	FAUCET SDDCDLH 12SGN 2.20 GPM	\$303.00
31801	HANDLE 3/4 X 3/8 ALUM AN	\$11.00
32000	CTL VLV 8AWCDLH SVL SV	\$251.00
32010	CTL VLV 8SAWCDLH SVL SV	\$430.00
32027	REEL RINSE WHITE CVD CEILING 30 FT SV	\$2,039.00
32069	FAUCET ECONO 8AWLH 10SS	\$181.00
32500	FAUCET 8AWCDLH 06SS	\$292.00
32510	FAUCET 8AWCDLH 08SS	\$296.00
32520	FAUCET 8AWCDLH 10SS	\$306.00
32530	FAUCET 8AWCDLH 12SS	\$307.00
32540	FAUCET 8AWCDLH 14SS	\$309.00
32697	SS PR-ERINSE SPG 16R	\$466.00
32840	SPRAY GUN	\$1,053.00
33000	CTL VLV 8DCDLH SVL SV	\$257.00
33100	FAUCET 8DCDLH 06SS	\$327.00
33110	FAUCET 8DCDLH 08SS	\$333.00
33120	FAUCET 8DCDLH 10SS	\$335.00
33130	FAUCET 8DCDLH 12SS	\$336.00
33140	FAUCET 8DCDLH 14SS	\$378.00
33150	FAUCET 8DCDLH 12SGN 2.20 GPM	\$349.00
33219	FAUCET ECONO 8AWLH 14SS	\$183.00
33324	HOSE MOLEX 1/2M X 3/8M 35 FT	\$346.00
33332	HOSE MOLEX 1/2M X 3/8M 50 FT	\$454.00
33340	HOSE RRA SVL X 1/2F X 35 FT WITH GUN ADAPTER	\$1,172.00

ITEM #	ITEM DESCRIPTION	PRICE
33359	HOSE RRA SVL X 1/2F X 50 FT	\$1,766.00
33413	HOSE RRA 1/2M X 1/2F X 2 FT	\$115.00
33693	FAUCET ECONO 8AWLH 08SS	\$209.00
34160	PR-ERINSE SPG SDDCDLH 06SS	\$783.00
34190	PR-ERINSE SPG SDDCDLH 12SS	\$773.00
34220	PR-ERINSE SPG 8DCDLH 06SS	\$832.00
34260	PR-ERINSE SPG 8DCDLH 12SS	\$852.00
34350	PR-ERINSE SPG 8AWCDLH 06SS	\$781.00
34370	PR-ERINSE SPG 8AWCDLH 10SS	\$809.00
34390	PR-ERINSE SPG 8AWCDLH 12SS	\$828.00
34400	PR-ERINSE SPG 8AWCDLH 14SS	\$832.00
34410	PR-ERINSE SPG 8BSCDLH 12SS	\$828.00
34450	PR-ERINSE SPG 8BSCDLH 10SS	\$821.00
34470	PR-ERINSE SPG 8BSCDLH 14SS	\$789.00
34480	PR-ERINSE SPG 8BSCDLH 16SS	\$831.00
34711	SS RISER PR 18	\$68.00
34878	ADPTR 1/2 BODY X 3/8M 303 CR	\$37.00
35000	CTL VLV 4DCDLH SVL SV	\$231.00
35100	FAUCET 4DCDLH 06SS	\$287.00
35110	FAUCET 4DCDLH 08SS	\$292.00
35120	FAUCET 4DCDLH 10SS	\$287.00
35130	FAUCET 4DCDLH 12SS	\$283.00
35150	FAUCET 4DCDLH 12SGN 2.20 GPM	\$301.00
35250	FAUCET 4DCDLH 06SGN 2.20 GPM	\$287.00
36000	CTL VLV 4BSCDLH SVL SV	\$251.00
36100	FAUCET 4BSCDLH 06SS	\$304.00
36130	FAUCET 4BSCDLH 12SS	\$307.00
36150	FAUCET 4BSCDLH 12SGN	\$352.00
36160	FAUCET CRCDLH 14SS	\$258.00
36730	ASPIRATOR W/ BALL VALVE	\$553.00
36951	HOSE RR FG 3/8M X 3/8F X 30 FT	\$285.00
37000	CTL VLV SWCDLH SVL SV	\$123.00
37100	FAUCET SWCDLH 06SS	\$160.00
37130	FAUCET SWCDLH 12SS	\$170.00
37150	FAUCET SWCDLH 12SGN 2.20 GPM	\$174.00
37419	HOSE FG 1/2 X 3/4-14 X 90 ELBOW	\$113.00
37427	HOSE FG 1/2 X 3/4-14 X 108 ELBOW	\$98.00
38296	SS CONTROL VALVE ADDONLH RIG SV 2	\$191.00
38318	SS CONTROL VALVE ADDONLH RIG SV 4	\$203.00
38326	SS RISER PR 02 1/2	\$31.00
38334	SS RISER PR 04 1/2	\$37.00
38350	SS RISER PR 08	\$41.00
38369	RISER PR 10	\$44.00
38660	SS PR-ERINSE SPG 21R	\$463.00

ITEM #	ITEM DESCRIPTION	PRICE
40000	SPOUT 11CSCD 5.00 GPM	\$192.00
41718	SS AERATOR 55/64-27F PCA SPRAY 0.35 GPM	\$13.00
41726	SS AERATOR 55/64-27F 5.00 GPM	\$19.00
41777	SS PR-ERINSE SPG 8BSLH 12SS 7 PLUS	\$1,182.00
42300	FAUCET 8AWCDLH 11CS07DJ	\$501.00
42310	FAUCET 8AWCDLH 11CS13DJ	\$511.00
42757	SOCKET 1/2 DRIVE 1 HEX	\$93.00
42811	DISK RETAINER 1/2 STEM FLAT ASSY	\$11.00
43001	ADPTR 3/8M X FMC SVLM NL BRS POL CR	\$27.00
43567	AXLE DBL SHORT 304 W/ 2 SNAP RINGS	\$24.00
44547	QUICK DISCONNECT BASE BACKSPLASH ECC 1/2M X 1/4 BARB	\$284.00
44600	FAUCET 4DCDWH 12SGN 2.20 GPM	\$354.00
44873	ADPTR 1/4F X 55/64-27M 304	\$22.00
45748	SS FAUCET BD 06SGN PER 2.20 GPM	\$143.00
46094	SS FAUCET BD 12SGN PER 2.20 GPM	\$151.00
47090	SS FAUCET BBS 06SGN PER 2.20 GPM	\$156.00
47104	SS FAUCET BBS 12SGN PER 2.20 GPM	\$164.00
47300	FAUCET SWCDLH 11CS07DJ	\$408.00
47310	FAUCET SWCDLH 11CS13DJ	\$410.00
47500	FAUCET CRCDLH 10SS	\$235.00
47550	CTL VLV CRCDLH SVL SV	\$187.00
47759	SS SGL FLOOR FOOT VALVE	\$264.00
47988	SS DUAL FLOOR FOOT VALVE	\$372.00
48011	SS SGL KNEE VALVE	\$288.00
48054	SS DUAL KNEE VALVE	\$372.00
48062	SS SGL WALL FOOT VALVE	\$302.00
48070	SS DUAL WALL FOOT VALVE	\$419.00
48880	PR-ERINSE SPG 8BSCDLH 06SS	\$869.00
48910	PR-ERINSE SPG 8BSCDLH 12SS	\$868.00
48920	PR-ERINSE SPG 8BSCDZLH 14SS	\$805.00
48930	PR-ERINSE SPG 8BSCDZLH 16SS	\$832.00
51403	SS STEM 3/4 SWIVEL RH STD KIT	\$75.00
51411	SS STEM 3/4 SWIVEL LH STD KIT	\$75.00
51446	DISK RETAINER 1/2 STEM SS ASSY	\$11.00
51659	SS ADPTR 1/4F X 3/4-14F	\$19.00
51675	FITTING 1/4M X 3/8M 304	\$31.00
51705	CLOSE NIPPLE 3/8 304	\$24.00
52426	HANDLE DRINKING SHORT STL CR PD	\$37.00
52434	DRINKING FLAT STRAINER BRS SHORT HANDLE	\$239.00
52760	SS FAUCET SDDLH 06SS	\$396.00
52795	SS FAUCET SDDLH 12SS	\$396.00
52841	SS FAUCET SDDLH 10SS07DJ	\$491.00
52892	SS FAUCET SDDLH 06SGN PER 2.20 GPM	\$414.00
52906	SS FAUCET SDDLH 12SGN PER 2.20 GPM	\$393.00

ITEM #	ITEM DESCRIPTION	PRICE
52922	SS PR-ERINSE SPG 8BSZLH	\$875.00
52930	SS PR-ERINSE SPG 8BSZLH 06SS	\$1,185.00
52965	SS PR-ERINSE SPG 8BSZLH 12SS	\$1,203.00
52973	SS PR-ERINSE SPG 8BSZLH 14SS	\$1,099.00
53007	SS PR-ERINSE SPG SDDLH	\$821.00
53015	SS PR-ERINSE SPG SDDLH 06SS	\$1,047.00
53058	SS PR-ERINSE SPG SDDLH 12SS	\$1,058.00
53104	SS FAUCET 8AWLH 06SS	\$484.00
53120	SS FAUCET 8AWLH 10SS	\$458.00
53121	SS FAUCET 8AWLH 10SS	\$491.00
53139	SS FAUCET 8AWLH 12SS	\$395.00
53430	SS PR-ERINSE SPG 8AWLH	\$843.00
53449	SS PR-ERINSE SPG 8AWLH 06SS	\$1,045.00
53457	SS PR-ERINSE SPG 8AWLH 08SS	\$1,088.00
53473	SS PR-ERINSE SPG 8AWLH 12SS	\$1,002.00
53740	SS FAUCET 4DLH 06SS	\$379.00
53775	SS FAUCET 4DLH 12SS	\$390.00
53872	SS FAUCET 4DLH 06SGN PER 2.20 GPM	\$386.00
53880	SS FAUCET 4DLH 12SGN PER 2.20 GPM	\$393.00
54100	SS FAUCET 8AWLH 12CS07DJ	\$620.00
54186	SS GLASS FILLER 10PED 3/8M	\$273.00
54194	SS GLASS FILLER 08PED 3/8M	\$268.00
54208	SS GLASS STATION 10PED	\$419.00
54224	SS GLASS FILLER HEAD FLAIR	\$217.00
54348	SS AERATOR 55/64-27F 1.00 GPM	\$19.00
54380	SS SPOUT 06SS 2.20 GPM	\$64.00
54399	SS SPOUT 08SS 2.20 GPM	\$66.00
54402	SS SPOUT 10SS 2.20 GPM	\$68.00
54410	SS SPOUT 12SS 2.20 GPM	\$76.00
54429	SS SPOUT 14SS 2.20 GPM	\$70.00
54437	SS SPOUT 12SGN 2.20 GPM	\$78.00
54445	SS SPOUT 16SS 2.20 GPM	\$77.00
54453	SS SPOUT 06SGN 2.20 GPM	\$69.00
54461	SS DJ 07	\$88.00
54502	SS STEM 1/2 CHECK RH STD KIT	\$37.00
54510	SS STEM 1/2 CHECK LH STD KIT	\$37.00
54518	SS STEM 1/2 SWIVEL RH STD KIT	\$37.00
54526	SS STEM 1/2 SWIVEL LH STD KIT	\$37.00
54577	STEM ADAPTER 1/2 RIGHT HAND 303 POL PAS	\$37.00
54593	STEM ADAPTER 1/2 LEFT HAND 303 POL PAS	\$37.00
54801	SS FAUCET 8AWLH 12CS12DJ	\$613.00
54836	SS FAUCET SBSELH 12CS12DJ	\$599.00
55042	SS SPOUT 12CS 5.00 GPM	\$213.00
55050	SS DJ 12	\$100.00

ITEM #	ITEM DESCRIPTION	PRICE
55250	PR-ERINSE SPG 8DCDLH INTERNATIONAL SALES ONLY	\$692.00
55778	PR-ERINSE SPG 21R INTL	\$369.00
55867	SS AERATOR 55/64-27F 2.20 GPM	\$20.00
56000	FAUCET CRCRLH 12SS	\$236.00
57630	SS FAUCET 8DLH 06SS	\$474.00
57649	SS FAUCET 8DLH 08SS	\$447.00
57657	SS FAUCET 8DLH 10SS	\$447.00
57665	SS FAUCET 8DLH 12SS	\$451.00
57673	SS FAUCET 8DLH 14SS	\$454.00
57770	SS FAUCET 8DLH 06SGN PER 2.20 GPM	\$398.00
57789	SS FAUCET 8DLH 12SGN PER 2.20 GPM	\$457.00
58009	SS FAUCET SDLH 06SS	\$262.00
58033	SS FAUCET SDLH 12SS	\$271.00
58130	SS FAUCET SDLH 06SGN PER 2.20 GPM	\$239.00
58149	SS FAUCET SDLH 12SGN PER 2.20 GPM	\$274.00
58696	SS FAUCET 4DWH 06SGN PER 2.20 GPM	\$442.00
58718	SS FAUCET 4DWH 12SGN PER 2.20 GPM	\$437.00
59099	SS GLASS FILLER 12PED 3/8M	\$275.00
59102	SS GLASS FILLER 14PED 3/8M	\$276.00
59110	SS GLASS STATION 12PED	\$430.00
59129	SS GLASS STATION 14PED	\$430.00
59919	ADPTR 3/8M X FMC SVLM 304 POL	\$37.00
60526	SS FAUCET 8BSELH 16SS	\$516.00
60658	SS FAUCET 8BSELH 14SS	\$489.00
60674	SS FAUCET 8BSZLH 14SS	\$495.00
60690	SS FAUCET 8BSLH 14SS	\$468.00
60801	SS FAUCET 8BSZLH 12SS	\$494.00
60836	SS FAUCET 8BSLH 12SS	\$463.00
60917	SS FAUCET 8BSELH 10SS	\$511.00
61077	SS FAUCET 8BSZLH 08SS	\$485.00
61204	SS FAUCET 8BSZLH 06SS	\$518.00
61220	SS FAUCET 8BSLH 06SS	\$468.00
61298	SS FAUCET 8BSLH 12SGN PER 2.20 GPM	\$479.00
61336	NIPPLE 1/2 X 1/4 X 6 304	\$38.00
61476	SS FAUCET 8BSLH 06SGN PER 2.20 GPM	\$473.00
61506	SS CONTROL VALVE 8BSZLH SVL SV	\$362.00
61549	SS CONTROL VALVE 8BSLH SVL SV	\$326.00
61557	SS CONTROL VALVE 8BSWH SVL SV	\$359.00
61565	SS CONTROL VALVE 8AWLH SVL SV	\$326.00
61573	SS CONTROL VALVE 8AWWH SVL SV	\$427.00
61662	SS CONTROL VALVE 8BSLH RIG CK	\$397.00
61689	SS CONTROL VALVE 8AWLH RIG CK	\$408.00
62049	SS FAUCET 4BSLH 12SS	\$440.00
62448	SS FAUCET 4BSLH 06SS	\$414.00

ITEM #	ITEM DESCRIPTION	PRICE
62502	SS FAUCET 4BSLH 12SGN PER 2.20 GPM	\$444.00
62510	SS FAUCET 4BSWH 12SGN PER 2.20 GPM	\$450.00
62669	SS FAUCET 4BSLH 06SGN PER 2.20 GPM	\$419.00
62677	SS FAUCET 4BSWH 06SGN PER 2.20 GPM	\$446.00
62839	SS CONTROL VALVE 4BSLH SVL SV	\$341.00
62847	SS CONTROL VALVE 4BSWH SVL SV	\$370.00
62936	SS CONTROL VALVE 4BSLH RIG CK	\$352.00
63134	SS CONTROL VALVE SDDLH RIG CK	\$317.00
63363	SS RISER PR 21	\$60.00
63592	SS CONTROL VALVE SDDLH SVL SV	\$326.00
63606	SS CONTROL VALVE SDDWH SVL SV	\$333.00
63810	CTL VLV 8BSCDZLH SVL SV	\$295.00
64211	CLOSE ELBOW 1/2 F BRS 2 EACH	\$54.00
64238	CLOSE NIPPLE 1/2 BRS 2 EACH	\$30.00
64351	SUPPLY LINE 1/2 F X 1/2 M X 36 2 EACH	\$100.00
64730	FAUCET 8BSCDZLH 06SS	\$361.00
64740	FAUCET 8BSCDZLH 08SS	\$351.00
64760	FAUCET 8BSCDZLH 12SS	\$337.00
64770	FAUCET 8BSCDZLH 14SS	\$338.00
64790	PR-ERINSE SPG 8BCDSLH	\$665.00
65676	DRAINING FLAT STRAINER VR BRS	\$239.00
65994	DUAL DECK MOUNTING KIT BRS	\$35.00
66575	SS CONTROL VALVE SDLH SVL SV	\$223.00
66583	SS CONTROL VALVE SDWH SVL SV	\$242.00
66591	SS CONTROL VALVE SDLH RIG SV	\$173.00
66761	BIBB CAP WIDESPREAD 304 POL	\$29.00
66869	SEAT 3/4 PRESS 303	\$24.00
67148	STEM 1/2 SINGLE RH STD ASSY	\$31.00
67385	SS CONTROL VALVE 8DLH SVL SV	\$384.00
67393	SS CONTROL VALVE 8DWH SVL SV	\$308.00
67407	SS CONTROL VALVE 8DLH RIG CK	\$376.00
67423	SS CONTROL VALVE 4DLH SVL SV	\$319.00
67458	SS CONTROL VALVE 4DLH RIG CK	\$302.00
67601	SS FAUCET SWLH 06SS	\$232.00
67644	SS FAUCET SWLH 12SS	\$245.00
67989	SS PR-ERINSE SPG 8BSLH	\$848.00
68071	SS PR-ERINSE SPG 8BSLH 06SS	\$1,137.00
68128	SS PR-ERINSE SPG 8BSLH 12SS	\$1,045.00
68217	SS PR-ERINSE SPG 8DLH	\$792.00
68225	SS PR-ERINSE SPG 8DLH 06SS	\$1,117.00
68268	SS PR-ERINSE SPG 8DLH 12SS	\$1,061.00
69175	SS FAUCET SWLH 12CS07DJ	\$454.00
69183	SS FAUCET SWLH 12CS12DJ	\$479.00
70424	SS CONTROL VALVE SWWH SVL SV	\$195.00

ITEM #	ITEM DESCRIPTION	PRICE
70432	SS CONTROL VALVE SWLH RIG SV	\$175.00
70459	SS CONTROL VALVE SWLH SVL SV	\$176.00
70645	SS CLOSE NIPPLE 1/2	\$21.00
70653	EZ INSTALL KIT SS T&S CHI KRN	\$76.00
70920	STOP WSLH RIGHT HAND SV FR B ITEM WHEN LIVE	\$210.00
71072	ULTRA SPRAY VALVE PLUS BLACK BUMPER INTL	\$115.00
71307	SS ULTRA SPRAY VALVE PLUS	\$176.00
71315	SS RISER PR 16	\$48.00
71323	SS FAUCET ADDONLH 06SS	\$250.00
71366	SS FAUCET ADDONLH 12SS	\$261.00
71374	SS FAUCET ADDONLH 14SS	\$268.00
71390	SS HANDLE 3/4-14F X 3/4-14F	\$37.00
71404	SS HOSE PR ASSY T&S 44	\$133.00
71412	REPAIR KIT GLASS FILLER SS	\$56.00
71420	REPAIR KIT SPRAY VALVE SS	\$69.00
71439	SS CLOSE NIPPLE 1/2 2 EACH	\$37.00
71447	SS CLOSE ELBOW 1/2F 2 EACH	\$100.00
71498	SS CLOSE ELBOW 1/2F	\$50.00
71668	SS STOP WSLH RIGHT HAND SV	\$158.00
71684	SS STOP WSLH LEFT HAND SV	\$156.00
71803	DUAL DECK MOUNTING KIT SS	\$76.00
72273	PR-ERINSE SPG 00R INTL	\$349.00
72726	LIFT PLUS ASSY	\$19.00
72747	RISER PR 02 1/2 NL BRS POL CR	\$24.00
72748	RISER PR 04 1/2 NL BRS POL CR	\$31.00
72749	RISER PR 25 NL BRS POL CR	\$52.00
72750	RISER PR 31 NL BRS POL CR	\$82.00
72792	DISK RETAINER GF / SV SS ASSY	\$6.00
72793	DISK RETAINER 3/4 STEM SS ASSY	\$16.00
72794	STEM 1/2 SWIVEL RH KEY STD ASSY	\$35.00
72813	SS HOSE / PIPE CHEMICAL TEE	\$81.00
72819	HANDLE DRINKING STL CR PD	\$24.00
73110	FAUCET CHEMICAL TEE	\$129.00
73120	PR-ERINSE SPG 8BSCDLH 16R INTERNATIONAL SALES ONLY	\$663.00
73130	PR-ERINSE SPG 8BSCDLH 16SS	\$804.00
73222	UNION 1/2F BRS	\$90.00
73228	SPRING GOOSENECK STL CR	\$39.00
73247	STEM 1/2 CHECK RH FLAT KIT	\$45.00
73248	STEM 1/2 CHECK LH FLAT KIT	\$45.00
73258	BASE GLASS FILLER BRS POL CR	\$37.00
73271	CLOSE NIPPLE, ELBOW & SUPPLY LINE 1/2 BRS	\$57.00
73320	PR-ERINSE SLP 8BCSDLH 08SS	\$757.00
73463	TWTH WASTE STOPPER W/ O-RING BRS CR	\$50.00
73470	KNOB DRINKING ZMK	\$88.00

ITEM #	ITEM DESCRIPTION	PRICE
73476	CLOSE NIPPLE 1/2 BRS CR	\$36.00
73477	NUT FLANGE / SPOUT 3/4	\$48.00
73481	ADPTR 3/4 BODY X FMC SVLM NL BRS CR	\$125.00
73482	ADPTR 3/8F X FMC SVLF 304 POL	\$27.00
73483	ADPTR 3/4F X FMC SVLM 304 POL	\$113.00
73484	THREAD COVER SW NL BRS POL CR	\$12.00
73493	WASHER .688 X 1 1/4 304 POL	\$9.00
73494	NOZZLE J 2.45 GPM 304	\$31.00
73495	NOZZLE VJ 1.15 GPM 304	\$37.00
73496	CLOSE NIPPLE 3/8 NL BRS CR	\$24.00
73500	ESCUTCHEON CON STOP 2 1/4 304 POL	\$44.00
73501	FLANGE ECCENTRIC 1/2 303 BN	\$9.00
73502	FLANGE 45 DEG 1/2 NL BRS POL CR	\$48.00
73521	LUBE PILLOW PACK O-RING	\$6.00
73522	SPOUT ECONO 14SS 2.20 GPM	\$48.00
73523	SPOUT ECONO 16SS 2.20 GPM	\$49.00
73524	SPOUT ECONO 06SGN 2.20 GPM	\$50.00
73525	SPOUT ECONO 12SS 2.20 GPM	\$47.00
73526	SPOUT ECONO 10SS 2.20 GPM	\$46.00
73527	SPOUT ECONO 08SS 2.20 GPM	\$44.00
73528	SPOUT ECONO 06SS 2.20 GPM	\$42.00
73532	NUT SLIP JOINT 1 1/2 BRS CR	\$11.00
73534	ADPTR 1/2 BODY X 3/8F 304 POL	\$37.00
73540	NUT CONNECTOR 1/2 303 POL PAS	\$19.00
73541	ECCENTRIC KIT SS 1/2F	\$44.00
73542	ADPTR 1/2 BODY X FMC SVLM 303 POL PAS	\$37.00
73543	BIBB CAP FAUCET 303 POL PAS	\$11.00
73544	WASHER SER .709 OD	\$4.00
73547	GASKET ECCENTRIC 3/4	\$7.00
73548	ECCENTRIC KIT BRS 3/4F	\$100.00
73549	ESCUTCHEON 3/4 BRS POL CR	\$11.00
73550	WASHER SEAT 3/4 STEM	\$5.00
73551	CONCENTRIC KIT SS 1/2M	\$37.00
73553	RETAINING RING 7/16	\$9.00
73554	AXLE DBL LONG BRS CR W/ 2 SNAP RINGS	\$24.00
73555	BRACKET FOOT VALVE NL BRS POL CR	\$50.00
73567	GASKET GRAY FIBER 3/4	\$5.00
73568	O-RING SPOUT 3/4	\$3.00
73569	ADPTR STEM 3/4 LEFT HAND NL BRS POL CR	\$76.00
73570	ADPTR STEM 3/4 RIGHT HAND NL BRS POL CR	\$76.00
73571	SEAT 3/4 PRESS 303	\$24.00
73572	HANDLE DRINKING LONG STL CR PD	\$37.00
73573	RISER GF 14 304 POL	\$113.00
73577	WASTE VLV KEY BRS BN	\$24.00

ITEM #	ITEM DESCRIPTION	PRICE
73578	NUT RETAINER DRINKING BRS CR	\$24.00
73584	GASKET INLET FITTING	\$3.00
73585	BALL VALVE 3/8M X 3/8F	\$43.00
73594	BASKET STRAINER	\$19.00
73596	O-RING TWIST WASTE	\$10.00
73597	HANDLE TWIST WASTE	\$50.00
73599	OVERFLOW ELBOW TWIST WASTE	\$58.00
73604	FLANGE WOK BRS POL CR	\$48.00
73605	RISER GF 12 304 POL	\$132.00
73606	RISER GF 10 304 POL	\$119.00
73607	RISER GF 08 304 POL	\$93.00
73612	STREET ELBOW 3/8 304 POL	\$35.00
73648	SEAT 1/2 THREAD 303	\$7.00
73652	STRAINER OVERFLOW ELBOW KIT	\$37.00
73654	DISK RETAINER CYLINDER FV 303	\$6.00
73655	GASKET END CAP BW	\$4.00
73656	END CAP OVERFLOW BRS	\$19.00
73657	GASKET DUCK STEM	\$3.00
73658	FITTING 3/8M X 1/2M X 1/4F 304	\$23.00
73661	STIFFNER PAN ALUM	\$37.00
73677	SPRING GOOSENECK MINI STL CR	\$84.00
73682	NUT SLIP JOINT 1 1/4 BRS CR	\$9.00
73683	GASKET SLIP JOINT 1 1/4	\$3.00
73684	NUT SPOUT 1/2 BRS POL CR	\$7.00
73685	WASHER SEAT NIT 1/2 STEM FLAT	\$3.00
73694	VOLUME CONTROL TEMP CONTROL ASSY	\$18.00
73697	ADPTR DRINKING STOP BRS	\$11.00
73706	NUT CONNECTOR 1/2 BRS CR	\$19.00
73707	TEE 3/8F NL BRS POL CR	\$88.00
73708	ELBOW 3/8F NL BRS POL CR	\$37.00
73709	GASKET	\$4.00
73716	O-RING GLASS FILLER VOLUME CONTROL	\$3.00
73718	SPRING FOOT VALVE	\$6.00
73725	PLUG 3/8M NL BRS POL CR	\$14.00
73750	FAUCET SENSOR SBSE 0.50 GPM	\$758.00
73751	FAUCET SENSOR SD 0.50 GPM	\$758.00
73770	DIPPERWELL BOWLS	\$116.00
73781	NUT LOCK 3/4 BRS 100 EACH	\$290.00
73782	STANDPIPE 3/4 X 3 1/4 BRS CR 100 EACH	\$1,090.00
73783	WASTE SOCKET 3/4 X 1 3/4 BRS CR 100 EACH	\$1,414.00
73784	GASKET WASTE SOCKET 3/4 100 EACH	\$164.00
73792	WASHER OVAL X 1 7/8 304 POL	\$17.00
73793	GASKET CYLINDER	\$4.00
73794	SLIP JOINT KIT 1/2	\$8.00

ITEM #	ITEM DESCRIPTION	PRICE
73805	NUT SPOUT 1/2 303 POL PAS	\$17.00
73806	O-RING LIFT PIN	\$3.00
73835	BIBB CAP TEMP CONTROL BRS	\$4.00
73836	ADPTR 1/2 BODY X FMC SVLM NL BRS CR	\$29.00
73838	WASHER .692 X 1 3/4 STEEL	\$4.00
73848	NUT LOCK 1 1/8-20 BRS	\$6.00
73849	WASHER 1.182 X 1 7/8 SS	\$9.00
73853	SPOUT SRVSNK 3 X 1/2M NL BRS POL CR	\$87.00
73856	ADPTR 1/4M X 55/64-27M BRS CR LONG	\$17.00
73857	AXLE SGL SHORT 303 CR W/ 2 SNAP RINGS	\$24.00
73858	PEDAL KNEE ALUM AN	\$108.00
73862	NUT LOCK 3/8 BRS	\$10.00
73878	SCREW SOCKET M4 X 16MM	\$3.00
73885	SEAT DW THREAD 303	\$6.00
73929	PEDAL WALL ALUM AN	\$119.00
73930	PEDAL FLOOR ALUM AN	\$76.00
73931	NIPPLE 3/8 X 2 5/16 BRS	\$11.00
73932	SCREW MACHINE 2-56 X 1/4	\$3.00
73933	WASHER SEAT DIPPERWELL	\$4.00
73934	O-RING DIPPERWELL	\$3.00
73940	BALL STOP FOR 1/2 HOSE	\$74.00
74000	GLASS FILLER HASI 96	\$580.00
74049	QD PLUG 1/4 PORT 2ST 1/4 BODY X BARB 3/8 SS	\$23.00
74050	LEVER PUSH BRS POL CR	\$25.00
74223	AERATOR 55/64-27F PCA SPRAY 0.35 GPM	\$8.00
74238	WASHER .843 X 1 1/2 BRS CR	\$17.00
74247	TUBE 12RGN SCRUB 304 POL CR	\$46.00
74267	ADPTR 1 1/2F X 2M BRS CR	\$29.00
74307	SS STEM 1/2 CHECK RH FLAT KIT	\$63.00
74309	SS STEM 1/2 CHECK LH FLAT KIT	\$63.00
74313	NUT HEX CYLINDER FV 10-24 18-8 SS	\$3.00
74334	SS AERATOR 55/64-27F 1.50 GPM	\$19.00
74335	AERATOR 55/64-27F PER 1.50 GPM	\$19.00
74336	AERATOR 55/64-27F PER 1.00 GPM	\$19.00
74439	GASKET WASTE VALVE 200 EACH	\$87.00
74547	BIBB CAP CON STOP BRS CR	\$39.00
74556	NUT DRINKING ROTOR / SPOUT BRS CR	\$10.00
74581	O-RING SPOUT 1/2 QTY 20	\$10.00
74590	PR-ERINSE SPG 4DCDLH 16R INTERNATIONAL SALES ONLY	\$609.00
74618	CONTROL VALVE ECONO 8AWLH SVL SV	\$197.00
74628	UTILITY VALVE W/O SPRAY HEAD	\$154.00
74652	AXLE SGL LONG 303 CR W/ 2 SNAP RINGS	\$24.00
74693	NIPPLE 1/2 X 1 3/8 NL BRS DLP	\$8.00
74728	SS GLASS FILLER HEAD 3/8F	\$209.00

ITEM #	ITEM DESCRIPTION	PRICE
74752	ADPTR WS TEE 303 PAS	\$24.00
74791	SS PR-ERINSE SLP 8BSZLH 12SS	\$1,178.00
75016	SERVICE SINK HOSE & HOLDER KIT	\$108.00
75066	HOSE RR 3/8M X 1/2F X 1 1/2 FT	\$65.00
75079	HOSE RR 3/8M X 3/8M X 30 FT	\$302.00
75110	HOSE RR FG 3/8M X 1/2F X 1 1/2 FT	\$57.00
75117	VACUUM BREAKER ATMOSPHERE 1/2	\$146.00
75121	THREAD COVER CHEMICAL TEE 304	\$14.00
75199	REEL RINSE SWING BRACKET REELCRAFT RED	\$262.00
75200	REEL RINSE PIVOT BASE REELCRAFT BLACK	\$291.00
75221	REEL RINSE SS CVD WALL 30 FT X 3/8 SV	\$4,430.00
75222	REEL RINSE SS CVD CEILING 30 FT X 3/8 SV	\$4,633.00
75300	PR-ERINSE SPG 8BSCDLH 21R INTERNATIONAL SALES ONLY	\$666.00
75303	ADPTR 1/4M X 3/8F NL BRS	\$24.00
75356	NUT SPOUT 1/2 CD BRS POL CR	\$30.00
75395	REEL SS EXP WALL 50 FT SV	\$4,934.00
75397	REEL SS EXP WALL 50 FT SG	\$6,747.00
75408	PR-ERINSE SLP 10R	\$360.00
75410	PR-ERINSE SLP 04R	\$351.00
75411	SS PR-ERINSE SLP 04R	\$471.00
75414	PR SVLM / PIPE CHEMICAL TEE	\$60.00
75423	HOSE RR 3/8M X 3/8F X 20 FT	\$208.00
75427	HOSE RR FG 3/8M X 3/8M X 12 FT	\$130.00
75464	KEY STOP KEY	\$23.00
75480	PR-ERINSE SLP 4DCDLH 06SS	\$665.00
75496	GAS HOSE 3/4M X 48 W/ ACCESSORIES	\$425.00
75497	GAS HOSE 3/4M X 36 W/ ACCESSORIES	\$425.00
75498	GAS HOSE 1/2M X 48 W/ ACCESSORIES	\$335.00
75499	GAS HOSE 1 X 48M W/ ACCESSORIES	\$575.00
75555	SPRING STYLE GLASS FILLER 21R	\$550.00
75557	EZ INSTALL KIT BRS T&S CHI KRN	\$56.00
75564	SPRING STYLE GLASS FILLER 16R	\$384.00
75568	POT FILLER SVB 60 ASSY	\$699.00
75570	POT FILLER SVB 96 ASSY	\$895.00
75571	GLASS FILLER SVB 60 ASSY	\$699.00
75572	GLASS FILLER SVB 96 ASSY	\$892.00
75573	POT FILLER SVE 60 ASSY	\$699.00
75574	POT FILLER SVE 96 ASSY	\$770.00
75575	GLASS FILLER SVE 60 ASSY	\$699.00
75576	GLASS FILLER SVE 96 ASSY	\$767.00
75577	UTILITY SPRAY SVB 60 ASSY	\$699.00
75579	UTILITY SPRAY SVB 96 ASSY	\$699.00
75580	UTILITY SPRAY SVE 60 ASSY	\$699.00
75581	UTILITY SPRAY SVE 96 ASSY	\$780.00

ITEM #	ITEM DESCRIPTION	PRICE
75586	PR-ERINSE SVL 25R	\$410.00
75588	AERATOR 13/16-27M PCA SPRAY 0.35 GPM	\$16.00
75594	PR-ERINSE SPG 16R 7 PLUS	\$419.00
75595	PR-ERINSE SPG 21R 7 PLUS	\$427.00
75596	SS PR-ERINSE SPG 16R 7 PLUS	\$480.00
75597	SS PR-ERINSE SPG 21R 7 PLUS	\$571.00
75598	PR-ERINSE SLP 04R 7 PLUS	\$354.00
75599	PR-ERINSE SLP 10R 7 PLUS	\$367.00
75600	SS PR-ERINSE SLP 04R 7 PLUS	\$429.00
75602	PR-ERINSE SVL 25R 7 PLUS	\$450.00
75603	PR-ERINSE SVL 31R 7 PLUS	\$484.00
75613	QUICK DISCONNECT PR-ERINSE	\$531.00
75625	SUPPLY LINE 1/2F X 1/2F X 36 2 EACH	\$100.00
75626	HANDLE KIT WRIST 2 EACH	\$100.00
75655	SS HOSE / PIPE CHEMICAL TEE W/ COVER	\$98.00
75673	HOSE / PIPE CHEMICAL TEE NL BRS CP	\$55.00
75697	GASKET DRAIN FLANGE BOTTOM	\$6.00
75698	SCREW SHEET METAL 10 X 3/4	\$5.00
75708	ADPTR DRINKING STOP BRS CR	\$20.00
75709	ADPTR DRINKING OVERFLOW BRS	\$30.00
75710	ADPTR DRINKING OVERFLOW BRS CR	\$40.00
75788	REPLACEMENT SWIVEL 5600 OLS BUNA-N O RINGS	\$623.00
75789	REPLACEMENT SWIVEL 7800 OLS BUNA-N O RINGS	\$1,220.00
75793	PLUG 3/8M 304 POL	\$30.00
75797	REPLACEMENT SWIVEL 5600 OLS BUNA-N O RINGS	\$642.00
75799	AERATOR 13/16-27M NEOSTRAHL	\$16.00
75801	NEOSTRAHL FULL FLOW STREAM STRAIGHTENER 55/64-27	\$8.00
75811	REPLACEMENT SWIVEL 7800 OLS BUNA-N O RINGS	\$1,237.00
75854	BALL VALVE 3/8M X 3/8F LEVER	\$10.00
75869	CLOSE NIPPLE 1/2 X 2 3/8 NL BRS	\$16.00
75895	GASKET LF BODY	\$2.00
75918	CONTROL VALVE ADDONLH RIG SV 2R	\$109.00
75946	SS CONTROL VALVE 8DLH SVL CK	\$358.00
75953	JOINT SWIVEL REEL RINSE COX	\$236.00
75958	STEM 1/2 CERAMIC DISK LH	\$29.00
75959	STEM 1/2 CERAMIC DISK RH	\$29.00
75965	DJ 12	\$119.00
75966	DJ 07	\$123.00
75979	GAS HOSE 3/4" SWIVEL	\$175.00
75980	GAS HOSE 1" SWIVEL	\$246.00
75986	SPOUT 12SS NO AERATOR	\$50.00
75987	SPOUT 06SS NO AERATOR	\$45.00
75988	SPOUT 08SS NO AERATOR	\$47.00
75989	SPOUT 10SS NO AERATOR	\$49.00

ITEM #	ITEM DESCRIPTION	PRICE
75990	SPOUT 14SS NO AERATOR	\$51.00
75991	SPOUT 16SS NO AERATOR	\$52.00
75992	SPOUT 12SGN NO AERATOR	\$61.00
75993	SPOUT 06SGN NO AERATOR	\$54.00
76899	FLANGE ECCENTRIC ¾ 304	\$16.00
77860	¾ SPOUT 12SGN	\$142.00
80100	FAUCET 4BSCDWH 12SGN 2.20 GPM	\$390.00
80690	FAUCET 4BSCDEWH 06SGN 2.20 GPM	\$408.00
81345	REEL RINSE WHITE CVD CEILING 30 FT US	\$2,244.00
81930	INLET FITTING ASSY 3 GASKETS	\$38.00
82252	HOSE PR W/O SS 96	\$145.00
82260	UTILITY SPRAY HAS 96 W/O SS	\$360.00
82530	FAUCET 8AWCDZLH 06SRV	\$437.00
82610	FAUCET 8SAWCDLH 06SRV	\$609.00
82767	CLOSE NIPPLE ½ BRS 20 EACH	\$254.00
82775	CLOSE ELBOW ½F BRS 20 EACH	\$477.00
83895	GLASS STATION 14PED	\$372.00
83940	PR-ERINSE SPG 8TBSCDLH 12SS 7 PLUS	\$818.00
84010	CTL VLV 8TBSCDLH RIG CK	\$338.00
84085	WASTE SOCKET 1 X 2 BRS WITH GASKET & LOCK NUT	\$31.00
84093	WASTE SOCKET 1 X 4 BRS WITH GASKET & LOCK NUT	\$55.00
84800	FAUCET 4DCDWH 06SGN 2.20 GPM	\$336.00
84820	FAUCET 8BSCDELH 12SS	\$356.00
88310	FAUCET ADDONCDLH 12SS 2R	\$152.00
88850	PR-ERINSE SPG 8DCDLH 16R INTERNATIONAL SALES ONLY	\$697.00
89494	GLASS STATION 12PED	\$408.00
89613	SS STEM ½ SWIVEL LH FLAT KIT	\$42.00
89621	SS STEM ½ SWIVEL RH FLAT KIT	\$44.00
90450	PR-ERINSE SVL 8ABSCDLH	\$816.00
90470	FAUCET 4BSCDWH 06SGN 2.20 GPM	\$349.00
90850	FAUCET SBCDSXH SPRAY	\$233.00
91020	FAUCET 8AWCDLH 16SS	\$322.00
91103	ULTRA SPRAY HAL 36	\$242.00
91190	FAUCET CHCDLH 12SS	\$236.00
91540	FAUCET 4DCDWH 06SS	\$325.00
91710	FAUCET 8ABSCDLH 12SS	\$327.00
97098	REEL RINSE WHITE CVD WALL 30 FT SV / CONTROL UNIT 2 BOXES	\$4,921.00
97365	GLASS FILLER HAS 60 W/O SS	\$259.00
97993	PR-ERINSE SPG 16R	\$412.00
98094	FAUCET ECONO 8AWLH 12SS	\$219.00
98108	FAUCET ECONO 8AWLH 16SS	\$220.00
99449	¾ PR-ERINSE SPG 8BSELH 14SS	\$1,478.00
1000-0001	DISK RETAINER GF / SV BRS ASSY	\$11.00

ITEM #	ITEM DESCRIPTION	PRICE
1000-0003	LIFT PIN 303 BN ASSY	\$11.00
1000-3301	NUT BONNET STAMP NL BRS POL CR	\$24.00
1000-3416	SCREW AXLE GF BRS BN	\$8.00
1000-5001	WASHER BONNET	\$5.00
1000-5003	WASHER SEAT SOFT GF/SV	\$3.00
1000-5006	WASHER SEAT SOFT CYLINDER	\$3.00
1000-5008	O-RING PR-ERINSE FERRULE	\$4.00
1000-6001	SPRING GLASS FILLER	\$5.00
1000-7502	SCREW MACHINE 10-24 X ½	\$3.00
1000-8001	INSERT CORRUGATED GF BN	\$10.00
1000-8100	PRONG GF DELRIN	\$11.00
1117-WB	SPRING STYLE GLASS FILLER SDLH	\$539.00
1400-0000	GLASS STATION SINK	\$170.00
1400-5000	GASKET WASTE SOCKET ¾	\$5.00
1400-8503	GRILL ELEVATED WIRE PD	\$51.00
1600-5000	O-RING SPOUT ½	\$3.00
1600-7000	SCREW MACHINE 10-24 X 5/8 PIN IN HEX	\$6.00
1802-0000	STEM ½ SWIVEL RH LONG STD KIT	\$34.00
2000-0001	DISK RETAINER ½ STEM BRS ASSY	\$10.00
2000-0002	HANDLE KIT LEVER	\$16.00
2000-3002	BIBB CAP FAUCET BRS CR	\$11.00
2000-3304	ADPTR 3/8F X FMC SVLF NL BRS POL CR	\$37.00
2000-5000	WASHER .468 X .812 SS	\$3.00
2000-5003	WASHER SEAT HARD ½ STEM	\$3.00
2000-6000	SPRING CHECK VALVE	\$3.00
2000-7500	SCREW MACHINE 10-24 X ½	\$3.00
2000-8000	BUTTON INDEX HOT-RED	\$3.00
2000-8001	BUTTON INDEX COLD-BLUE	\$3.00
2011-0000	SWIVEL PR-ERINSE ARM	\$178.00
2200-0000	CLOSE NIPPLE ½ BRS	\$16.00
2200-5000	GASKET ECCENTRIC ½	\$5.00
2211-0000	PR-ERINSE SVL 31R	\$452.00
2400-2103	CLOSE ELBOW ½F BRS	\$24.00
2510-WB	PR-ERINSE SPG 4DLH	\$666.00
2805-CV	CONTROL VALVE 4RLH CK	\$273.00
2900-3309	ADPTR ¼F X 3/8M 304	\$19.00
2900-3310	ADPTR ¼F X 3/8F 304 POL	\$44.00
2900-3312	BUSHING 3/8F X ½M 304 POL	\$35.00
2900-5000	O-RING TEMP CONT	\$4.00
2902-12	WALL BRACKET 12	\$29.00
2902-7000	SCREW SET ¼-20 X ¼	\$4.00
2909-5000	GASKET LIFT PIN GUIDE	\$3.00
2909-6000	CLIP SPRAY VALVE	\$4.00

ITEM #	ITEM DESCRIPTION	PRICE
2912-6000	SPRING SPRAY VALVE	\$3.00
2912-7501	SCREW SOCKET 10-32 X 1/4	\$3.00
2913-3406	ADPTR 3/4-14F X 3/8M 304	\$20.00
2913-3407	FITTING 3/8M X 3/4-14M 304	\$24.00
2913-38	HANDLE 3/4-14F X 3/8F	\$34.00
2914-FG	HOSE FG 36	\$99.00
2915-FG	HOSE FG 60	\$110.00
2916-1512	HOSE PR 15	\$69.00
2916-2512	HOSE PR 25	\$82.00
2918-68	HOSE PR ASSY T&S 68	\$182.00
2922-3401	ADPTR 7/8-20F X 3/4-14F 304	\$29.00
2922-5000	GASKET HANDLE	\$3.00
2924-6000	SPRING GOOSENECK STL CR	\$53.00
2925-6300	HOSE HOOK POL CR	\$7.00
2926-3300	HOSE / PIPE 1/4F X 3/8F NL BRS POL CR INTL	\$27.00
2927-4300	RISER PR 21 NL BRS POL CR	\$65.00
2927-4302	RISER PR 12 NL BRS POL CR	\$52.00
2927-4303	RISER PR 16 NL BRS POL CR	\$52.00
2932-0002	DUAL CHECK VACUUM BREAKER 3/4-14F X 3/4-14M CR	\$286.00
2932-8000	VACUUM BREAKER ATMOSPHERE 1/4	\$164.00
2932-8001	REPAIR KIT AVB 1/4 & 3/8	\$69.00
2932-8002	VACUUM BREAKER ATMOSPHERE 3/8	\$171.00
2935-8000	VACUUM BREAKER ATMOSPHERE 3/4	\$243.00
2936-9000	CHECK VALVE 1/2F X 1/2F	\$292.00
2937-9000	WATER HAMMER SILENCER 1/2M	\$197.00
2949-3001	NOZZLE VJ 1.15 GPM BRS	\$31.00
2949-8600	WASHER CUP SV	\$4.00
2949-9000	BUMPER SPRAY VALVE BLACK	\$10.00
2949-9001	BRUSH SPRAY VALVE	\$47.00
2949-9002	BUMPER SPRAY VALVE BLUE	\$11.00
2954-3300	CLAMPING RING BRS CR	\$76.00
2954-3303	EYEWASH HEAD 3/8 BRS POL CR	\$37.00
2955-3400	ADPTR BUMPER 1/4F X 3/8M NL BRS RC	\$21.00
2955-8000	DUAL CHECK VACUUM BREAKER 3/8F X 3/8M CR	\$274.00
2970-3	TEMPERATURE ADJUST VALVE 1/2TP	\$129.00
2980-3000	HOSE END 3/8M ASSY	\$92.00
2980-R002	HOSE BEND RESTRICTOR	\$17.00
2980-R020	HOSE DURO 3/8M X 3/8F 1 1/2 FT	\$51.00
2980-R027	BALL STOP 3/8	\$58.00
2980-R028	HOSE DURO 3/8M X 3/8F X 35 FT	\$347.00
2981-R000	HOSE DURO 3/8M X 3/8F 30 FT	\$305.00
2984-3400	FITTING 1/4M X 3/8M NL BRS CR	\$29.00
2984-R020	HOSE DURO 3/8M X 3/8F X 12 FT	\$145.00
2990-3001	SPRAY NOZZLE NL BRS ASSY	\$34.00

ITEM #	ITEM DESCRIPTION	PRICE
3000-0000	STEM 1/2 SWIVEL RH STD KIT	\$37.00
3000-0001	STEM 1/2 SWIVEL LH STD KIT	\$37.00
3000-0003	DJ 7 1/4	\$123.00
3000-0010	STEM 1/2 SWIVEL LH STD ASSY	\$29.00
3000-0011	STEM 1/2 SWIVEL RH STD ASSY	\$29.00
3000-3304	STEM ADAPTER 1/2 RIGHT HAND	\$24.00
3000-3305	STEM ADAPTER 1/2 LEFT HAND NL BRS CR	\$24.00
3000-3309	ADPTR 1/2 BODY X 3/8F NL BRS CR	\$31.00
3000-5001	GASKET GRAY FIBER	\$3.00
3000-5002	GASKET WASTE VALVE	\$3.00
3000-6001	SEAT 1/2 PRESS 303	\$5.00
3000-8003	SEAT DJ PRESS 303	\$4.00
3042-0000	STEM KIT DIPPERWELL RIGHT HAND SINGLE XH KIT	\$75.00
3070-0000	CYLINDER KIT FOOT VALVE BRS	\$54.00
3070-7001	RING SNAP FV SS	\$6.00
3071-3303	BIBB CAP FV/DW BRS CR	\$11.00
3200-2306	ESCUTCHEON 1/2 ZMK POL CR	\$11.00
3200-2307	ECCENTRIC KIT BRS 1/2F	\$37.00
3900-0002	BASE BACKSPLASH RIG	\$76.00
3982-9000	ADPTR GHM X 55/64-27F 304	\$11.00
4000-0002	DJ 13	\$119.00
4000-0004	HANDLE KIT KNOB	\$24.00
4000-3300	ADPTR 3/8F X FMC SVLM 304 POL	\$67.00
5000-0001	3/4 SPOUT 10SS	\$113.00
5000-0002	3/4 SPOUT 14SS	\$129.00
5000-0003	3/4 DJ 10	\$182.00
5000-0006	STEM 3/4 SWIVEL LH STD ASSY	\$55.00
5000-0007	STEM 3/4 SWIVEL RH STD ASSY	\$55.00
5000-0010	STEM 3/4 SWIVEL RH STD KIT	\$75.00
5000-0011	STEM 3/4 SWIVEL LH STD KIT	\$75.00
5000-0012	STEM 3/4 CHECK RH STD KIT	\$67.00
5000-0013	STEM 3/4 CHECK LH STD KIT	\$67.00
5000-2103	CLOSE ELBOW 3/4F	\$75.00
5008-0002	HOSE FG 3/4 72	\$584.00
5200-CV	3/4 CONTROL VALVE 8AWLH SVL CK	\$702.00
5300-CV	3/4 CONTROL VALVE 8DLH SVL CK	\$456.00
5400-CV	3/4 CONTROL VALVE 8BSELH SVL CK	\$612.00
6124-4400	TUBE OVERFLOW 19 X 21 NL BRS CR	\$54.00
6125-4400	TUBE OVERFLOW 14 X 16 NL BRS CR	\$54.00
6126-5000	GASKET DRAINING ELBOW STRAINER	\$5.00
6126-7400	SCREW MACHINE 10-24 X 2 1/2	\$6.00
6128-5000	GASKET TAILPIECE 2	\$6.00
6128-8000	NUT SLIP JOINT 2 BRS CR	\$21.00
6240-2100	WASTE SOCKET 1 X 2 BRS	\$23.00

ITEM #	ITEM DESCRIPTION	PRICE
6241-2400	WASTE SOCKET 1 X 2 BRS CR	\$44.00
6250-2100	NUT LOCK 1 BRS	\$7.00
6280-5000	GASKET WASTE SOCKET 1 / TAILPIECE 1 1/2	\$3.20
6440-2100	WASTE SOCKET 1 X 4 BRS	\$47.00
6441-2400	WASTE SOCKET 1 X 4 BRS CR	\$60.00
6540-2100	WASTE SOCKET 1 1/2 X 1 1/2 BRS	\$39.00
6541-2400	WASTE SOCKET 1 1/2 X 1 1/2 BRS CR	\$47.00
6544-0000	TAILPIECE 1 1/2 X 4 CR	\$37.00
6550-2100	NUT LOCK 1 1/2 BRS	\$10.00
6580-5000	GASKET WASTE SOCKET 1 1/2 FIBER	\$4.00

ITEM #	ITEM DESCRIPTION	PRICE
6642-2100	WASTE SOCKET 3/4 X 1 3/4 BRS	\$37.00
6651-9000	NUT LOCK 3/4 BRS	\$9.00
6673-4300	STANDPIPE 3/4 X 3 1/4 BRS CR	\$18.00
8250-2300	FLANGE WALL BRACE POL CR	\$44.00
8250-3300	ADJUSTER ROD 2 1/2 BRS POL CR	\$50.00
8250-3302	BRACKET ROD 10 3/4 BRS POL CR	\$62.00
8254-7000	SCREW MACHINE 10-32 X 1/2 PHIL OVAL	\$4.00
9041-9001	AERATOR SWIVEL RS/2.20 GPM	\$78.00
9048-5000	GASKET SCRUB	\$7.00
9048-5401	SCREEN FLAT SPRAY SS	\$31.00